

GLENN BURNT
ELECTRONIC

198 100

October, 1974 □ 75 cents

Electronic Servicing



A HOWARD W. SAMS PUBLICATION

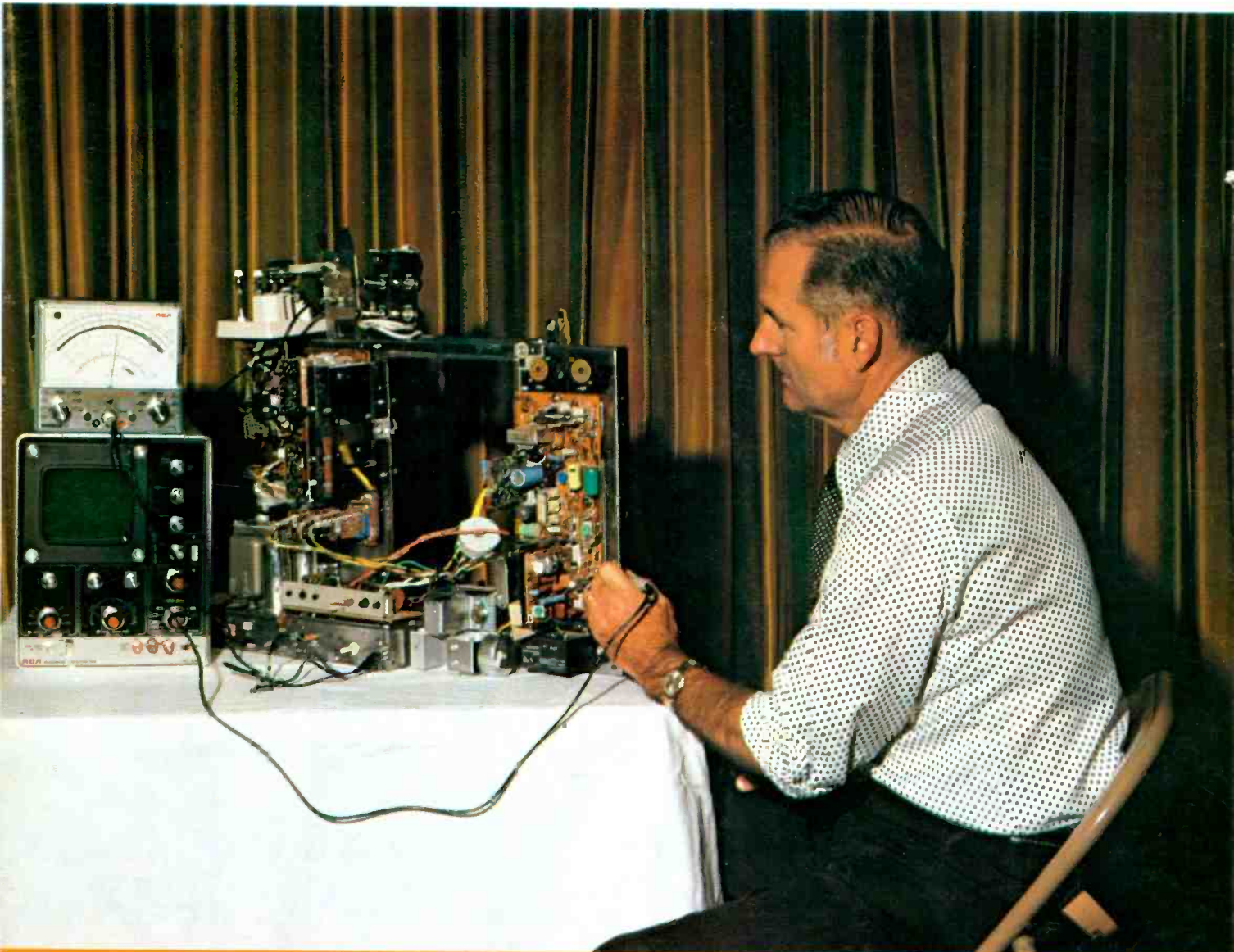

SERVICING SCR SWEEP

- Transistor Repairs
- Professional MATV Installations
- Other Side Of Warranty

PTS ELECTRONICS

Precision Tuner Service



now available near you

ALABAMA: PTS ELECTRONICS 524 32ND ST SOUTH BIRMINGHAM ALA. 35222 TEL. 205. 323-2647	CALIFORNIA—NORTH: PTS ELECTRONICS 4511 AUBURN BLVD SACRAMENTO, CALIF. 95841 TEL. 916. 482-6220	CALIFORNIA—SOUTH: PTS ELECTRONICS 5111 UNIVERSITY AVE SAN DIEGO, CALIF. 92105 TEL. 714. 280 7070	COLORADO: PTS ELECTRONICS 4896 ALLISON ST ARVADA, COLO. 80001 TEL. 303. 423-7080	FLORIDA—NORTH: PTS ELECTRONICS 12934 N.W. 7TH AVE MIAMI, FLA. 33168 TEL. 305. 685-9811	FLORIDA—SOUTH: PTS ELECTRONICS 1918 BLANDING BLVD JACKSONVILLE, FLA. 32210 TEL. 904. 389-9952	HOME OFFICE—INDIANA: PTS ELECTRONICS 5233 S. HWY. 37 BLOOMINGTON, IND. 47401 TEL. 812. 824-9331	KANSAS: PTS ELECTRONICS 3116 MERIAM LANE KANSAS CITY, KANSAS 66100 TEL. 913. 831-1222
TEXAS—EAST: PTS ELECTRONICS 4324 26 TELEPHONE RD HOUSTON, TEX. 77032 TEL. 713. 644-6793	<p>..new pts products.. ..pts 115 dura-seven..stop..seven piece alignment tool kit..stop..glass- filled polymer plastic for longer life.. ..stop..up to 10 times the life of regular plastic tools..stop ..\$2.49.. ..see your distributor or any pts service center..stop.. ..pts elex..not a franchise Co..</p>					LOUISIANA: PTS ELECTRONICS 2914 WYCKWOOD DRIVE METAIRIE, LOUISIANA 70033 TEL. 504. 885-2349	
TEXAS—NORTH: PTS ELECTRONICS MOPAC LANE LONGVIEW, TEX. 75601 TEL. 214. 753-4334						MARYLAND: PTS ELECTRONICS 1105 SPRING ST SILVER SPRING, MD. 20910 TEL. 301. 565-0025	
TENNESSEE: PTS ELECTRONICS 3614 LAMAR AVE MEMPHIS, TENN. 38118 TEL. 901. 365-1918						MASSACHUSETTS: PTS ELECTRONICS 191 CHESTNUT ST SPRINGFIELD, MASS. 01103 TEL. 413. 734-2737	
PENNSYLVANIA—WEST: PTS ELECTRONICS 257 RIVERVIEW AVE. W PITTSBURGH, PA. 15202 TEL. 412. 761-7648						MICHIGAN: PTS ELECTRONICS 13709 W. EIGHT MILE RD. DETROIT, MICH. 48235 TEL. 313. 862-1783	
PENNSYLVANIA—EAST: PTS ELECTRONICS 1921 S. 70TH ST PHILADELPHIA, PA. 19142 TEL. 215. 724-0999						MINNESOTA: PTS ELECTRONICS 815 W. LAKE ST MINNEAPOLIS, MINN. 55408 TEL. 612. 824-2333	
OREGON: PTS ELECTRONICS 5220 N.E. SANDY BLVD PORTLAND, OREGON 97213 TEL. 503. 282-9636						OKLAHOMA: PTS ELECTRONICS 3007 N. MAY OKLAHOMA CITY, OKLA. 73106 TEL. 405. 947-2013	OHIO—SOUTH: US TUNER SERVICE 8180 VINE ST CINCINNATI, OHIO 45215 TEL. 513. 821-2298

LET US TAKE CARE OF YOUR TUNER PROBLEMS...

PTS will repair any tuner - no matter how old or new - black & white or color - transistor or tubes - varactor or electronically tuned - detent UHF. 8 hour service is a must!

...THIS IS THE SERVICE WE OFFER:

1. Fastest Service—8 hour—in and out the same day. Overnight transit to one of our strategically located plants.
2. Best Quality—Your customers are satisfied and you are not bothered with returning tuners for rework.
3. PTS uses only ORIGINAL PARTS! No homemade or make-do, inferior merchandise (this is why we charge for major parts!). You get your tuner back in ORIGINAL EQUIPMENT condition.
4. PTS is recommended by more TV Manufacturers than any other tuner company.
5. PTS is overhauling more tuners than all other tuner services combined.



Fast **8** hr. Service!

We offer you finer, faster...

...Precision
Tuner Service



ELECTRONICS, INC....

...Number ONE and still trying harder!
(Not a Franchise Company)

1 YEAR GUARANTEE

VHF, UHF \$10.95
UV-COMBO 17.95
IF-SUBCHASSIS 12.50

Major parts and shipping charged at cost.
(Dealer net!)

Over 4000 exact tuner replacements available for \$14.95 up (new or rebuilt).

For More Details Circle (1) on Reply Card

The new Mallory CA3 Intrusion Alarm.

Reliable.



(And inconspicuous.)

This area-and-perimeter device creates and transmits an ultrasonic wavelength field for detection up to a distance of 20 feet. And because of its modern design and walnut-grain finish, the CA3 is attractive and inconspicuous enough to pass as a radio or stereo tuner.

Virtually any movement by an intruder (or a break in the perimeter circuit) activates the built-in horn and the remote outlet for two minutes. An automatic

reset handles the possibility of a new or renewed intrusion. And special CA3 circuitry guards against false alarms from line transients and insects. A variety of companion indoor or outdoor accessory devices is available.

The Mallory CA3 Ultrasonic Intrusion Alarm. From the manufacturer of the most complete line of do-it-yourself security products. Another sound reason to see your Mallory distributor today.

MALLORY

MALLORY DISTRIBUTOR PRODUCTS COMPANY

a division of P. R. MALLORY & CO. INC.

Box 1284, Indianapolis, Indiana 46206; Telephone: 317-856-3731

Batteries • Capacitors • Controls • Security Products • DURATAPE® • Resistors • Semiconductors • SONALERT® • Switches • Timing Devices and Motors

DURACELL® DURATAPE® and SONALERT® are registered trademarks of P. R. Mallory & Co. Inc.

electronic **SCANNER**

news of the industry

Matsushita Electric Industrial Company has developed a modular-type color television chassis which allows production time to be reduced 60% with the aid of automation equipment planned for their Ibaraki factory. The G4 chassis consists of the mother and five plug-in printed circuit boards carrying all of the important circuits, reports **Home Furnishings Daily**. Other Matsushita TV plants, and possibly the Quasar facility in the U.S., may have access to the new chassis and production facilities in the future.

As part of their program to build more safety, economy and convenience into their products, **U.S. automobile manufacturers are relying heavily on electronics**. By the end of 1979, sales of semiconductors for car uses are expected to reach \$1 billion annually. According to **Radio and Television Weekly**, principal electronic systems that can be incorporated in a typical automobile include anti-skid braking systems, fuel-injection systems, ignition systems, dashboard presentation, speed control and tachometer, system sensors to warn of mechanical or electrical problems, and seat belt/door opener interlocks.

The Arizona State Electronics Association has just come out with a new newspaper called **The SCANNER**. It is a news-filled tabloid-type paper, similar to the Arkansas **ANODE**.

Zenith Radio Corporation has introduced eight color TV sets, of which four are hybrid models. The hybrids are 90% solid state and carry no suggested list, reports **Home Furnishings Daily**.

Jules Steinberg, executive vice-president of the National Appliance and Radio-TV Dealers Association (NARDA), **stated that appliance-TV dealers should not have the responsibility for warehousing merchandise**. Every piece of merchandise the dealer owns should be on display in his store, but the warehousing responsibility should be in the hands of the wholesaler. According to **Home Furnishing Daily**, Steinberg suggested that the dealer own the merchandise but should get immediate delivery from the wholesaler's warehouse when he sells it to the customer.

Japanese color video systems have branched out into three directions with the introduction of a 1/2-inch parallel-reel color cassette VTR jointly developed by Toshiba and Sanyo. Designed for all three worldwide TV broadcasting systems, NSTC, PAL and SECAM, the new cassette will be introduced to the domestic and overseas markets around the end of the year, reports **Home Furnishings Daily**.

(Continued on page 6)

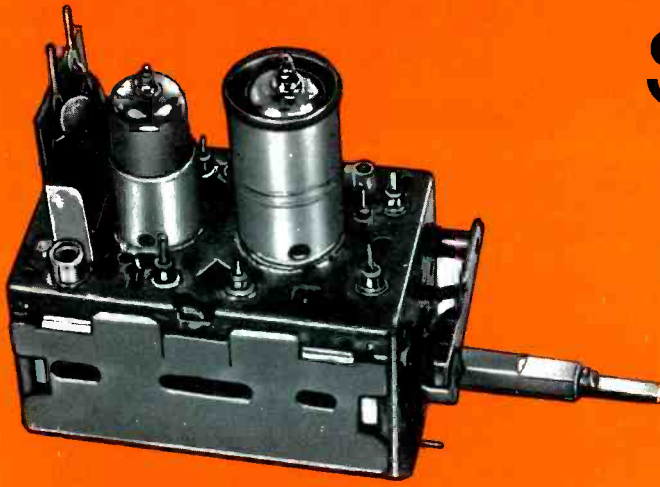

STILL ONLY \$9.95

U.S.A. ONLY
ALL PARTS INCLUDED
EXCEPT TUBES
& TRANSISTORS
ONE YEAR GUARANTEE

TUNER SERVICE CORPORATION

PROVIDES YOU WITH A
COMPLETE SERVICE FOR
ALL YOUR TELEVISION
TUNER REQUIREMENTS.

REPAIR

VHF Or UHF Any Type \$9.95.
UHF/VHF Combo \$15.00.

In this price all parts are included, tubes, transistors, diodes, and nuvistors are charged extra. This price does not cover mutilated tuners.

Fast efficient service at our conveniently located service centers.

All tuners ultrasonically cleaned, repaired, realigned and air tested.

REPLACE

Universal Replacement Tuner \$12.95 (In Canada \$15.95)

This price buys you a complete new tuner built specifically by **SARKES TARZIAN INC.** for this purpose.

All shafts have a maximum length of 10½" which can be cut to 1½".

Specify heater type parallel and series 450mA or 600mA.

CUSTOMIZE

Customized tuners are available at a cost of only \$15.95; (with trade-in \$13.95) (In Canada \$17.95/\$15.95)

Send in your original tuner for comparison purposes.



WATCH US
GROW

HEADQUARTERS	BLOOMINGTON, INDIANA 47401	537 S. Walnut Street	Tel. 812-334-0411
ARIZONA	TUCSON, ARIZONA 85713	1528 So. 6th Street, P.O. Box 4534	Tel. 602-791-9243
CALIFORNIA	NORTH HOLLYWOOD, CALIF. 91601	10654 Magnolia Boulevard	Tel. 213-769-2720
	BURLINGAME, CALIF. 94010	1324 Marsten Road	Tel. 415-347-5728
	MODESTO, CALIF. 95351	123 Phoenix Avenue	Tel. 209-521-8051
FLORIDA	TAMPA, FLORIDA 33606	1505 Cypress Street	Tel. 813-253-0324
GEORGIA	ATLANTA, GEORGIA 30310	938 Gordon Street S.W.	Tel. 404-758-2232
ILLINOIS	CHAMPAIGN, ILLINOIS 61820	405 East University Street	Tel. 317-356-6400
	CHICAGO, ILLINOIS 60621	737 West 55th Street	Tel. 312-873-5556-7
	SKOKIE, ILLINOIS 60076	5110 West Brown Street	Tel. 312-675-0230
INDIANA	HAMMOND, INDIANA 46323	6833 Grand Avenue	Tel. 219-845-2676
	INDIANAPOLIS, INDIANA 46204	112 W. St. Clair	Tel. 317-632-3493
KENTUCKY	LOUISVILLE, KENTUCKY 40208	2920 Taylor Boulevard	Tel. 502-634-3334
LOUISIANA	SHREVEPORT, LOUISIANA 71104	3025 Highland Ave.	Tel. 318-861-7745
MARYLAND	BALTIMORE, MD. 21215	5505 Reisterstown Rd., P.O. Box 2824	Tel. 301-358-1186
MISSOURI	ST. LOUIS, MISSOURI 63132	10530 Page Avenue	Tel. 314-429-0633
NEVADA	LAS VEGAS, NEVADA 89102	1412 Western Ave., No. 1	Tel. 702-384-4235
NEW JERSEY	JERSEY CITY, NEW JERSEY 07307	547-49 Tonnele Avenue HWY 1&9	Tel. 201-792-3730
	TRENTON, NEW JERSEY 08638	901 N. Olden Ave.	Tel. 609-393-0999
OHIO	CINCINNATI, OHIO 45216	7450 Vine Street	Tel. 513-821-5080
	CLEVELAND, OHIO 44109	4597 Pearl Road	Tel. 216-741-2314
OREGON	PORTLAND, OREGON 97210	1732 N.W. 25th Avenue	Tel. 503-222-9059
TENNESSEE	GREENEVILLE, TENNESSEE 37743	1215 Snapps Ferry Road	Tel. 615-639-8451
	MEMPHIS, TENNESSEE 38111	3158 Barron Ave.	Tel. 901-458-2355
TEXAS	DALLAS, TEXAS 75218	11540 Garland Road	Tel. 214-327-8413
VIRGINIA	NORFOLK, VIRGINIA 23513	3295 Santos Street	Tel. 804-855-2518
CANADA	ST. LAURENT, MONTREAL, QUEBEC H4N-2L7	305 Decarie Blvd.	Tel. 514-748-8803
	CALGARY, ALBERTA, T2H-0L1	448-42nd Avenue S.E., P.O. Box 5823 STN "A"	Tel. 403-243-0971

IF YOU WANT TO BRANCH OUT INTO THE TV TUNER REPAIR BUSINESS,
WRITE TO THE BLOOMINGTON HEADQUARTERS ABOUT A FRANCHISE

For More Details Circle (5) on Reply Card

To expand membership and recognize the diversification of traditional brown and white goods dealers, **the National Appliance and Radio-TV Dealers Association (NARDA) will consist of two divisions.** The key division will be composed of traditional NARDA brown and white goods retailers who will be designated members of the National Appliance and Radio-Electronics Dealers Association. The second division will be called the National Association of Retail Dealers of America and will be open to all business firms which sell products or services to the consumer, according to **Home Furnishings Daily.**

Mandatory state licensing of appliance, TV and radio repair services, uniform throughout the country, was advocated by **AMERICAN HOME** magazine in a recent editorial. The magazine suggested the following requirements for licensing: a service dealer would have to demonstrate competency, submit to an inspection of his facilities, post bond, pay an annual fee and adhere to the standards set by an advisory board (probably representing consumer interests as well as the appliance and electronic repair industry). Also, repairmen would have to provide a written estimate of the cost of labor and parts and issue an itemized invoice when the job is completed.

Miles Sterling, owner of Electro TV in Garden Grove, California, **is taking legal action** to bring the warranty rates given by some manufacturers at least up to the cost of doing business. Sterling found the laws in the California code that explicitly say it is illegal for persons to do business below their cost in order to do harm to the competition. These laws also specify that a manufacturer who tries to get dealers to do warranty work below their cost is equally guilty. The Board of Directors of the California State Electronics Association has adopted a resolution supporting the actions to be taken by Sterling, reports **The SCANNER.**

Canadian cable operators are listening eagerly to proposals for satellite nets in their country. Many earth stations are already in place because they are used in satellite service for radio, telephone and TV carriage to isolated communities.

A court in New Jersey has ruled that outdoor TV antennas atop the roofs of seven town houses in Winslow Township, a suburb of Camden, New Jersey, will have to be pulled inside. It might be practical for electronic trade associations to join in action against the ruling, because unless the decision is reversed by a higher court, it may set a precedent against the installation of outdoor antennas in many areas of the country, reports **Radio and Television Weekly.** □

Earn an extra \$2000 per year

Find out how you can earn an extra \$2000 or more per year restoring only a few color and black and white tubes per week. Full color brochure shows you how to make more money and satisfy more customers on almost every call. **Write today!**



New



467 CRT
Restorer/Analyzer
\$279*

With the profit restorer!

Profit in the home. After replacing a component you've often noticed a less than perfect picture. It's almost always due to a weak picture tube. The few minutes you spend with the 467 Restorer will give your customer brilliance and sharpness that will make her pleased to pay for the improved picture.

Profit in the shop. "Sixty-five dollars and the picture still doesn't look as good as it used to!" How many times have your customers said that to you? You need not hear it again! Use the 467 Restorer on every major job and your customer will thank you for returning his set working like new.

Most-Powerful Rejuvenation, but most gentle too. There's only one CRT Restorer that restores the picture to like new and analyzes tube condition so accurately that you can safely guarantee restoration for up to five years. You get extra safety from our automatic restoration method that prevents cathode stripping.

TriDynamic true test. The B & K TriDynamic method tests all three guns simultaneously. It measures true beam current that passes through G1 aperture, unlike other testers that measure meaningless cathode to G1 current. Leakage indication even includes cathode-to-cathode and there's an exclusive B & K focus continuity test.

Simplest operation. Exclusive integrated circuitry lets you test all picture tubes with the same, defined-on-the-front-panel procedure . . . including "in-line", Trinitron and tubes with common G1 and G2. See your distributor or write Dynascan.

*Six sockets included; optional sockets also shown.

B & K PRODUCTS OF
DYNASCAN
1801 W. Belle Plaine Ave.
Chicago, IL 60613 • (312) 327-7270



Winegard 82-ch. CW-1001
with AC-982 preamplifier*

The \$197⁰⁰ package that solves the toughest ones!

Our most expensive antenna package is one of our best sellers. And that's not too surprising.

There are lots of people who live in difficult reception areas who demand the best possible picture quality. And they are willing to pay for it.

To satisfy that demand for excellence in TV reception, antenna dealers who have "tried them all" frequently end up recommending the CW-1001 with Winegard's special high gain, low noise preamp. A great combination that makes the picture look good and makes you look good.

What Makes The CW-1001 Different? Check These Winegard Features:

- Unique wedge design offers increased signal capture area in a much shorter and more compact antenna.
- VHF vertical beam phasing rejects interferences such as airplane and auto ignition noise.
- Patented UHF driven element assembly and patented parabolic reflector screen provide unprecedented gain in an all band antenna.
- Special lightning protection circuit prevents static electricity build-up and arcing.
- FM control elements allow attenuation of strong FM signals where they interfere with TV reception.

- Choice of 300 or 75 ohm download.
- New truss construction with three mast clamps and super strong ellipsoidal booms of special aluminum alloy team up to provide rugged resistance to wind and weather.

Special High Gain, Low Noise Preamps

- Winegard's finest. Designed for the ultimate in deep fringe reception.
- High gain and low noise insures near perfect, snow-free color.
- Two-section high pass filter and switch selectable FM trap.
- Unique lightning protection circuit.
- For 75 ohm download only.

This great combination of antenna and preamplifier represents the finest effort of twenty years of Winegard television reception research. See your distributor or write Winegard Company.

*For VHF only, use CW-2002 with AC-913 preamplifier.

WINEGARD
TELEVISION SYSTEMS
Winegard Company / 3000 Kirkwood Street
Burlington, Iowa 52601

For More Details Circle (58) on Reply Card

readers'exchange

Needed: Service data for Commodore mono record player. Commodore has moved from address given in Photofact Index.

H. D. Wright
BW Electronics, Inc.
708 Glover Avenue
Enterprise, Alabama 36330

Needed: Schematic and service information for Automarine Instruments model 400 tach/dwell meter.

T. C. Johnson
820 State Street
Lemont, Illinois 60439

Needed: Schematic for an Atwater Kent model 35 receiver, serial number 1031062.

William R. Hansen
904 S.E. 187th Street
Portland, Oregon 97233

Needed: Meter for Superior Instruments model 592 volt-ohmmeter.

Ralph B. Thackeray
1012 Western Avenue
Champaign, Illinois 61820

Needed: Service data for model CF Solar Exam-eter capacitor checker.

Beasley's T.V. Service
504 East Methvin, Box 1628
Longview, Texas 75601

Needed: Schematic for model 106B "Lucky Strike" Geiger counter made by Precision Radiation Instruments, Inc.

James Lawson
J-R Electronics Maintenance
861 Catalina Drive
Livermore, California 94550

Needed: Tube test data booklet after MRC 3-1-65 for Precision model 10-12, 10-15, 10-20, or 10-54 tube tester. Will buy, or copy and return. Also, need schematic and manual for Supreme Instruments scope model 546. Will buy, or copy and return.

Edward Schoener
P.O. Box 44
New Ringgold, Pennsylvania 17960

Needed: 8-inch b-w picture tube number P/N 210HB4 for Sony portable TV model 8-301W.

John F. Botzer
34 Gedney Circle
White Plains, New York 10605

For Trade: Willing to share advice and schematics for repair of burglar alarm equipment.

Silvas Custom Services
6361 1st Avenue South
Seattle, Washington 98100



DID YOU KNOW HOT DIP GALVANIZING COSTS \$0.20 per pound ?



ROHN's

No. 25G Tower
Section weights
40# x 20¢ = \$8.00
Mfg. Cost

ROHN's

No. 20G Tower
Section weights
30# x 20¢ = \$6.00
Mfg. Cost

■ If you are purchasing towers which are not HOT DIP GALVANIZED your cost should be at least \$8.00 or \$6.00 less.

ROHN[®] MANUFACTURING

DIVISION OF



P.O. BOX 2000 / PEORIA, ILL. 61601

"Supplying tower needs worldwide for over 25 years."

For More Details Circle (7) on Reply Card

The GREATEST TV Schematic Bargain EVER Offered!

Complete TV Schematics for less than 5c each

COVERS ALL COLOR TV 1960-1968 AND 23 BRANDS B & W FROM 1965-1968

Here are FABULOUS savings on nationally-known TV schematic and service data—on everything you need to fill your vital service data needs for TV model years 1965 through 1968 . . . plus COLOR TV from 1960 through 1968! It amounts to a low, low cost of less than \$9.00 per year for your TV service data . . . with 5 more years of Color TV coverage thrown in for good measure!

SERVICE DATA FOR 23 BRANDS

TV TECH/MATICS includes complete schematic diagrams and vital servicing data for every TV receiver produced by more than 20 leading American Manufacturers for 1965, 1966, 1967, and 1968. All diagrams and servicing details are completely authentic. Each year's coverage is permanently bound into two convenient-to-use volumes which open flat to 11" x 29½", ready to provide you with instant service data at your workbench. Some diagrams as large as 58" x 22"!

HERE'S WHAT YOU GET

You receive 8 BIG volumes in all. Included is a clearly detailed and annotated TV schematic diagram for each specific model. You also get complete replacement parts lists, alignment instructions, tube and component location diagrams, plus key waveforms and voltage readings . . . all the information you need to service over 90% of the TV receivers you'll encounter!

Each volume is organized alphabetically by manufacturer, then numerically by model number. In addition, a handy Chassis/Model Finder is bound into each volume. Regular list price for each year's coverage—2 BIG volumes—is \$19.90. All 8 volumes normally sell for \$79.60. Your price is ONLY \$35.95 . . . a savings of nearly \$45.00!

MONEY-BACK GUARANTEE

Order at our risk for FREE 10-day examination. Prove to yourself they are worth many times the price.

CONTENTS

The 8 BIG volumes (2 for each year) cover all black-and-white receivers for model years 1965 through 1968—PLUS Color TV coverage from 1960 through 1968—for these brands: Admiral, Airline, Andrea, Coronado, Curtis Mathes, Dumont, Electrohome, Emerson, Firestone, General Electric, Hoffman, Magnavox, Motorola, Muntz, Olympic, Packard-Bell, Philco, Philco-Ford, RCA Victor, Sears Silvertone, Setchell-Carlson, Sonora, Sylvania, Truetone, Westinghouse and Zenith.

Publisher's List Price each year \$19.90 . . . Total \$79.60. Special price \$35.95 only while they last!



\$3.95 BONUS OFFER
Send remittance with order and we'll add 5 different SINGLPAK Manuals (79c list each)! These are 16p. reprints of mfr's TV data . . . yours at no extra charge.

LARGE PAGES, 15x11", open flat to 29½x11". Provides complete schematic diagrams.

NO RISK COUPON—MAIL TODAY

TAB Books, Blue Ridge Summit, Pa. 17214

- I enclose \$35.95 Please send me your complete 8-Vol. Tech/Matics Schematic Offer postage prepaid...plus my 5 FREE SINGLPAK Manuals.
- Please invoice me for \$35.95 plus postage. Same return privileges.

Name _____ Phone _____

Company _____

Address _____

City _____ State _____ Zip _____

Foreign, add 10%. Pa. add 6% sales tax. ES-104

troubleshootingtips

Send in your helpful tips—we pay!

No brightness Zenith 4B25C19 color chassis (Photofact 1166-3)

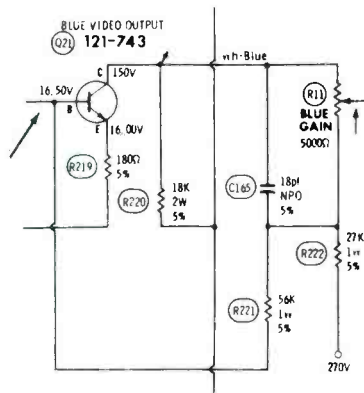

When first brought to the shop, the receiver had a total loss of brightness. However, the high voltage was normal, and this directed my suspicion towards the video stages.

In the service position of the set-up switch, there was no horizontal line, but I could obtain one by turning up the screen controls. Now when I flipped the switch back to normal, the brightness was good, but the contrast was very weak. The effect resembled a picture tube with a cathode-to-heater short. However, the picture tube was okay. The color bar pattern was perfect.

These symptoms pointed towards the video stages, so I replaced the 1st, 2nd, and 3rd video-amplifier transistors. There was no improvement. Both the brightness-limiter and vertical-blanking circuits checked okay.

Video waveforms and amplitudes checked fine up to the emitter of the 3rd video amplifier, where the peak-to-peak amplitude was only about 1/6th of the normal amount. I replaced the transistor again, and also the red, blue and green video output transistors, but there was no improvement.

The situation had gotten to be real hairy. Chroma at the bases of the red, blue and green video transistors was normal, but the video at the emitters was weak.

As a last resort I decided to change the demodulator IC, be-

cause it was connected to the bases. To my complete astonishment, the picture came on with normal video and increased brightness. Voltage measurements around the video-output transistors showed the bases were about one volt more positive than with the defective demodulator IC. I can't explain why a bias change of the video output transistors weakened the video in the 3rd video stage.

Gerald Martin
Colwich, Kansas

Intermittent HV Philco 19QT87 color chassis (Photofact 1026-3)

When the picture went black, the horizontal-output tube developed a bright-red plate. New horizontal tubes didn't fix it, so I brought the chassis to the shop.

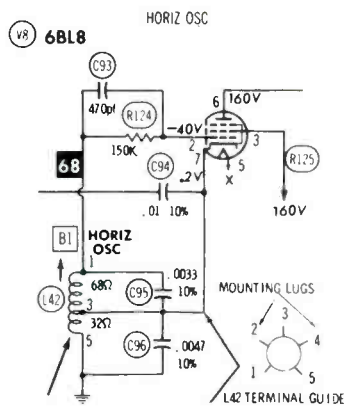

After a lot of testing, I found the oscillator voltages going all wrong. Checking from the cathode of the oscillator tube to ground, I found an open in the bottom half of the oscillator coil. Evidently it would open after the chassis got warm.

George Blunk
Fort Dodge, Iowa

Got A Troubleshooting Tip?

If you've recently run across an unusual trouble symptom, send a thorough description of it and the solution to:

Troubleshooting Tip,
Electronic Servicing
1014 Wyandotte St.
Kansas City, Mo. 64105

Avoid serious trouble in color TV sets by using the right replacement capacitor!

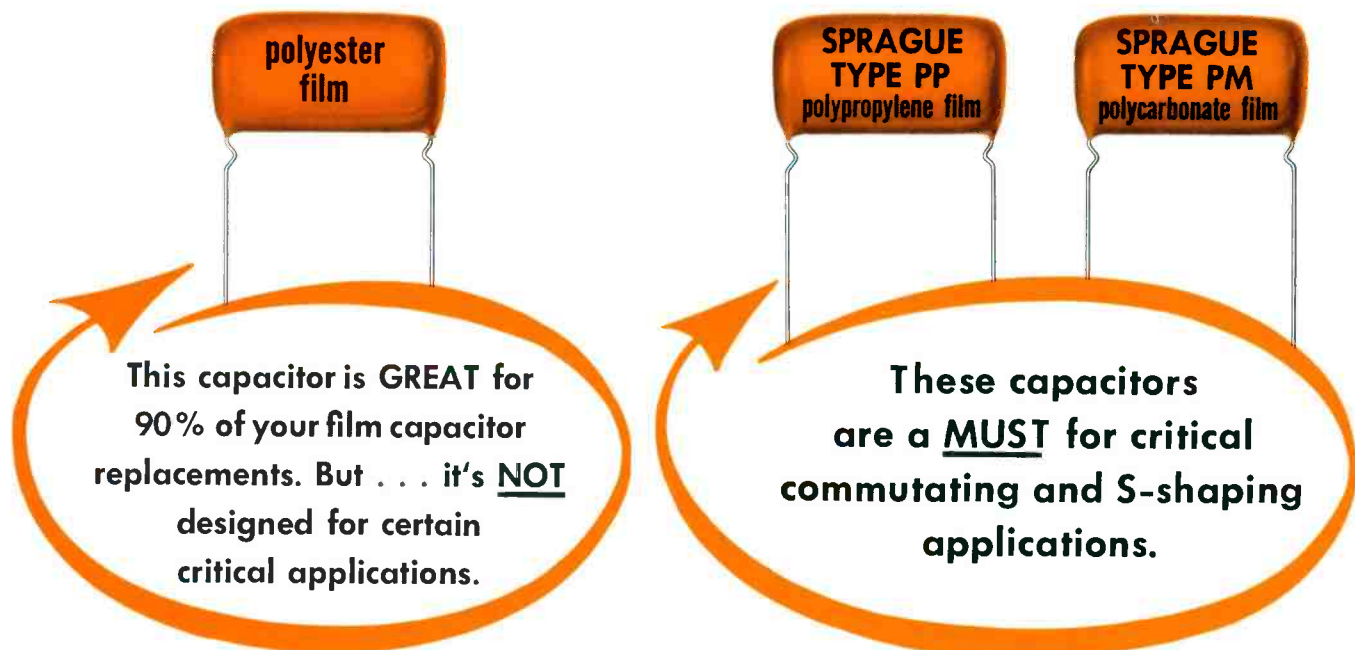

The next time you replace a dipped tubular in one of the newer color TV sets, don't automatically assume you're replacing an ordinary every-day film or paper capacitor. If it happens to be a deflection capacitor used for commutating or S-shaping, you need a polypropylene or polycarbonate film replacement with (1) high a-c current-carrying capability; (2) close capacitance tolerance; (3) good capacitance stability. The standard replacement

capacitors used in the industry, even our superior Type PS dipped tubulars, just won't do the job . . . and they could cause serious trouble after the set is put back into operation.

Play it safe . . . dipped tubulars may look alike on the surface, but there can be a big difference in the film dielectric. Keep a supply of Sprague Type PP and PM capacitors on hand for those critical situations where ordinary replacements won't work.

SPRAGUE TYPE PP POLYPROPYLENE FILM TYPE PM POLYCARBONATE FILM CAPACITORS

μF @ WVDC	Cap. Tol.	D. x L.	Cat. No.	μF @ WVDC	Cap. Tol.	D. x L.	Cat. No.
1.75 @ 100	$\pm 5\%$.900 x 1.000	PM1-M1.75	.0039 @ 600	$\pm 5\%$.400 x .800	PP6-D39S
1.5 @ 150	$\pm 5\%$.800 x .937	PM15-M1.5	.01 @ 600	$\pm 5\%$.500 x 1.250	PP6-S10S
.01 @ 400	$\pm 5\%$.400 x .750	PP4-S10	.066 @ 600	$\pm 5\%$.800 x 1.250	PP6-S66S
.015 @ 400	$\pm 5\%$.450 x .750	PP4-S15	.075 @ 600	$\pm 5\%$.750 x 1.250	PPS-S75S
.033 @ 400	$\pm 5\%$.500 x .750	PP4-S33S	.022 @ 800	$\pm 3\%$.600 x 1.300	PP8-S22S
.06 @ 400	$\pm 5\%$.800 x 1.250	PP4-S60S	.047 @ 800	$\pm 5\%$.700 x 1.250	PP8-S47S
.081 @ 400	$\pm 2\%$.600 x 1.300	PP4-S81S	.051 @ 800	$\pm 5\%$.800 x 1.250	PP8-S51S
.2 @ 400	$\pm 5\%$.700 x 1.700	PP4-P20	.0018 @ 1600	$\pm 5\%$.500 x 1.300	PP16-D18
.0018 @ 600	$\pm 5\%$.400 x .750	PP6-D18S	.002 @ 1600	$\pm 5\%$.500 x 1.300	PP16-D20
.0022 @ 600	$\pm 5\%$.400 x .750	PP6-D22S	.0033 @ 1600	$\pm 5\%$.550 x 1.300	PP16-D33
				.0039 @ 1600	$\pm 5\%$.600 x 1.300	PP16-D39

For cross-reference information on close-tolerance polypropylene and polycarbonate film capacitors, showing original part numbers with correct Sprague replacements, ask your Sprague distributor for Cross-Reference Guide C-873, or write to: Sprague Products Company, 105 Marshall Street, North Adams, Mass. 01247.

THE BROAD-LINE PRODUCER OF ELECTRONIC PARTS



The other side of warranty

By Carl Babcoke

Last month, we presented three related articles about warranties of home-entertainment electronic products. All three writers were critical of **some** practices of **some** manufacturers. We had hoped to give distributors or manufacturers equal space to tell their side of the story. Unfortunately, few spokesmen have elected to make rebuttals.

Before I review their answers, let me recap some of the history of warranty and how it has evolved to fit the changing industry conditions over the years.

Radio warranty

Years ago, long before television, administration of the warranty on radios and radio/phono combinations was strictly the responsibility of each individual selling dealer. Participation of the manufacturers was limited to supplying service data, and replacement of defective parts found within the first 90 days. A technician would bring a bad tube to the local distributor and receive a new one in even exchange. Labor was paid by the selling dealer.

Apparently, the reasoning behind this procedure was that the machines were simple (compared to modern color sets, for example) and warranty was not a big factor. There was very little discounting of selling prices, and every dealer was expected to set aside a small fund to cover warranty costs.

Everyone was happy with this state of affairs, except possibly the technicians who were almost invariably underpaid. The manufacturers liked the simplicity. They were not faced with the frustrating and expensive job of estimating future warranty costs so they could be included in the selling price. (Warranty is never free!)

Complaints, too, were handled by the local dealer; the manufacturers

stayed behind the bulwark of the written warranty and preferred not to be bothered.

Retail dealers were satisfied (in general) with the status quo. After all, they could hire one of the bright boys of the neighborhood, equip him with a VOM and a cheap tube tester, and have their warranty work done for peanuts. (My first radio-repair job paid \$7 per week.)

The advent of television began a slow buildup of pressure for radical changes.

Early television warranty

Because the first television manufacturers were the same ones who had been building radios, the first TV warranties were identical to the previous ones for radios. Many of those ancient b-w sets were sold with an extra charge for a labor service contract. The customer paid **directly** for his warranty. Still not too many ripples.

The impact of color sets

When color receivers began to be popular in the early 1960's, the pressure for major warranty changes began to rise up. There were several major reasons, such as:

- color sets are much more complicated than b-w, and therefore more skill was demanded of the technician (and also the customer);
- the manufacturers seemed unaware that the power companies had boosted the average line voltages some 10 to 15 volts, causing as much as three or more times the normal tube failure rate;
- parts and tube failures no longer were happening predominantly during the first 90 days, and customers became enraged over the expenses;
- many of the technicians began to feel they should be paid according to their skill and experience, and the disagreements and name-calling increased.

For several years the industry continued under the same ground rules, but the sniping increased between customers, technicians, dealers, distributors and manufacturers, each group blaming all the others.

Solid state and consumerism

But it was the twin blows of solid state and consumerism that finally tipped the scales and forced the manufacturers to pay labor charges and become involved with the individual customer. The added complications of servicing solid-state circuits spawned the modular concept, which has proven to be a mixed blessing to the technicians.

Next, the manufacturers found themselves (perhaps unwillingly) in a race to extend the warranty time periods. This is similar to the horsepower race in the auto industry and the wattage race in stereo products. Although many warranties have now stabilized at one year for parts and labor plus two years for picture tubes, there are exceptions, such as 10 years (or a lifetime) on solid-state components.

What's wrong with present warranty?

On the surface, it would seem the present warranties on both parts and labor would please everyone. But why are so many service dealers complaining bitterly? Briefly stated, warranty repairs never have been profitable to service dealers. However, when they were a small part of the total business, the losses or break-even could be absorbed without difficulty. Now that solid state has reduced the average amount of post-warranty service and the warranty times are so long, service dealers feel they cannot ignore these losses of income.

Here's just one example. A service dealer must stock many costly modules. During the first

year, there are expenses but no income. He must tie up his money (under high interest rates) and often pay taxes on the components, yet if he uses one for warranty he receives a new one in exchange, without even compensation for his direct expenses. To add injury to injury, it's possible he lost money on the warranty service call.

The Manufacturer's Story

Representatives of electronic manufacturers seem reluctant to talk about warranty problems. In the first place, warranty terms and conditions now play a major part in advertising and provide additional incentives to the customers to buy. So, they feel they should not disclose their future plans prematurely. There's a possibility, too, that a thorough airing of their views might include some measure of criticism of certain individuals or organizations. More enemies they don't need!

Also, they might point a finger at independent shops and say: "You talk about losing money on warranty repairs. Where are accurate figures showing your costs?" Do **you** know your exact cost of every area of your operations?

It's illegal for any group to agree among the individual members to set prices or exact terms of any kind.

Yet some such action would be necessary for the manufacturers to get off the spiral of warranty terms. If only one reduced warranty times or terms, he would be at a decided disadvantage in retail sales. Therefore, it's likely the manufacturers would like to cut back on warranties, but see no way to do it without competitive losses.

One well-known and highly-respected national service manager stated off-the-record that labor warranty is a very expensive way to give away money and make many people unhappy at the same time! Another negative aspect is that warranty tends to make accountants and policemen out of good factory field-service reps. Because of the small retail sales margin, it's natural for selling dealers to grasp every opportunity to make a few extra pennies; therefore, such

disputed services as set-up, when paid by the factory, have become an automatic part of the profit on the sale. Thus the intent of the warranty has been distorted.

A representative of another company made the point that manufacturers should be treated as individuals just as independent servicers should be. Not all manufacturers are guilty of warranty abuses. That's a good point.

A resolution calling for a realistic 90-day warranty on consumer-electronic products was passed unanimously at the August national convention of NATESA.

Home Furnishings Daily published an article with opinions and quotes about warranty from several prominent electronic manufacturers. RCA said it was reviewing the NATESA recommendation with interest, and that the greater reliability of present sets might make it appropriate for manufacturers to re-examine the warranty length. GTE-Sylvania said the company was backing away from longer warranties, and that two Sylvania portable color sets now have 90-day

warranties. Sony voiced the opinion that manufacturers within a couple of years would go back to 90-day warranties on solid-state receivers. General Electric forecast no immediate warranty changes. Panasonic said any change would have to be weighed in light of the consumerism movement. Zenith stated that some failures in which the company has responsibility occur after 90 days, therefore the customer benefits from the one-year warranty. Quasar said no changes of the one-year warranty are contemplated because the customers prefer it.

Summary

Perhaps by next month some of the manufacturers will consent to be quoted. Right now most seem intent on not creating "waves." I have never met a factory man who was deliberately trying to take advantage of service dealers. Perhaps they're guilty of being pre-occupied with their own problems. Therefore, I urge people on both sides to use moderation and courtesy and to work together to solve the problems. □

What would you expect an IMA to do?



- Perform SMPTE intermodulation analyses quickly and easily, even in the millivolt range?
 - Measure amplifier noise?
 - Measure transistor noise?
- Evaluate magnetic tape drop-out?
- Test oscillator amplitude stability?
- Measure tape recording distortion?
- Evaluate phono stylus wear and tracking?
- Test electromechanical transducers for intermodulation?

The Crown IMA does all of it. Internal intermodulation distortion is less than 0.005%. Write us for more complete information and application notes.



CROWN INTERNATIONAL

1718 W. MISHAWAKA ROAD ELKHART, INDIANA 46514 219-294-5571

For More Details Circle (9) on Reply Card

Rare cases of SCR-sweep defects

By Vilis Karitons

Horizontal sweep with SCR's began with the RCA CTC40 chassis in 1968. Since that time 12 other RCA solid-state models have used this same general circuit. An understanding of the circuit theory doesn't always guide us to the defective part, because some symptoms are difficult to analyze. We're presenting these true case histories to help you troubleshoot SCR-sweep circuits.

#1 Circuit Breaker Tripped Erratically RCA CTC40 (Photofact 1030-2)

Occasionally, the circuit breaker would trip when the set first was turned on. After the breaker was reset, the receiver would operate okay all evening. Two months later, the breaker started tripping several times per night, but at no predictable time.

In the customer's home, we replaced the SCR's and damper diod-

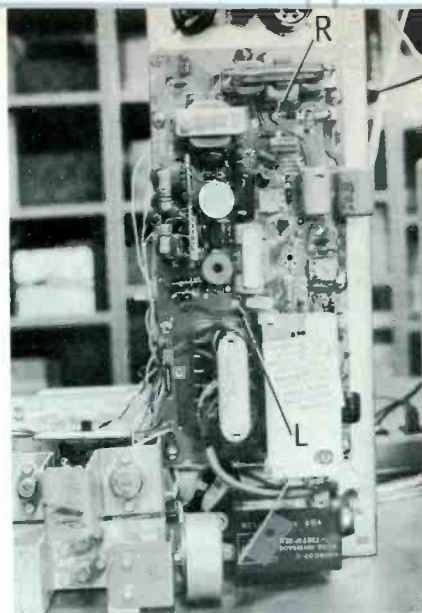

Arrows point to some of the components and test points of the RCA CTC58 chassis. The CTC48 is nearly the same, and other XL-100 chassis are similar.

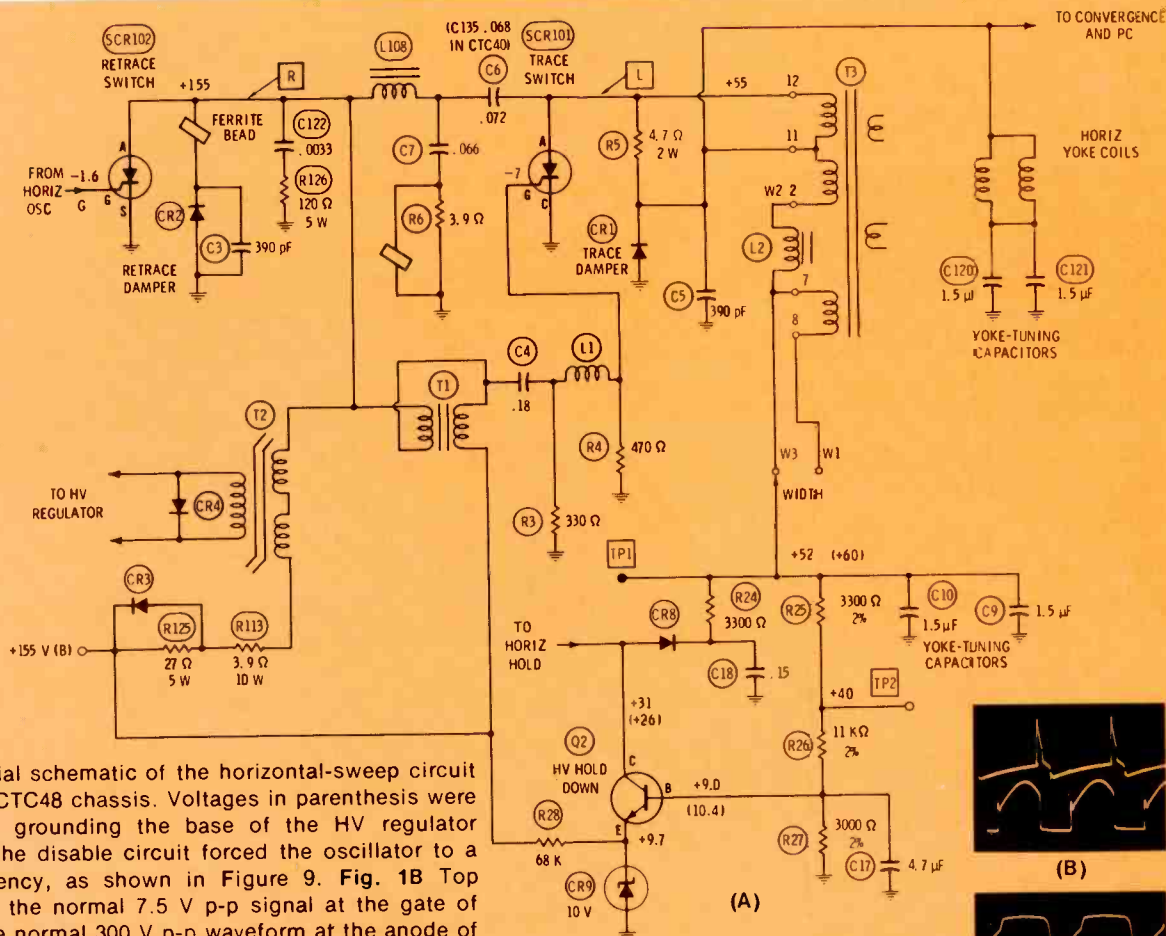

Fig. 1A Partial schematic of the horizontal-sweep circuit of the RCA CTC48 chassis. Voltages in parenthesis were obtained by grounding the base of the HV regulator transistor. The disable circuit forced the oscillator to a lower frequency, as shown in Figure 9. Fig. 1B Top waveform is the normal 7.5 V p-p signal at the gate of SCR102. The normal 300 V p-p waveform at the anode of SCR102 (point "R") is shown by the lower trace. Fig. 1C Waveform at the top is the normal 35 V p-p drive signal at the gate of SCR101, and the bottom trace is normal for the 500 V p-p anode signal of SCR101.

Now Channel Master guarantees the amplifiers you installed a year ago!

And two--and even three years ago--because all Channel Master Antenna Mounted Amplifiers and Home System Amplifiers made since January 1971 are guaranteed for four full years from date of manufacture!

- With Free Replacement anytime within the first year
- And Replacement at a Pro-rated Charge anytime within 3 years after that, giving you
- Full 4 Year Warranty Protection the strongest coverage in the antenna systems equipment industry!

It's possible because the reliability and performance of our Spartan Series Amplifiers have proved to be their own guarantee--and this performance and reliability have been engineered into the entire line!

So now, instead of the usual 90 day wondering whether the equipment you've installed is going to perform, rest in confidence--Channel Master is offering you the finest product with the strongest warranty protection in the business!

Channel Master Antenna Systems Equipment with 4 Year Warranty Protection!

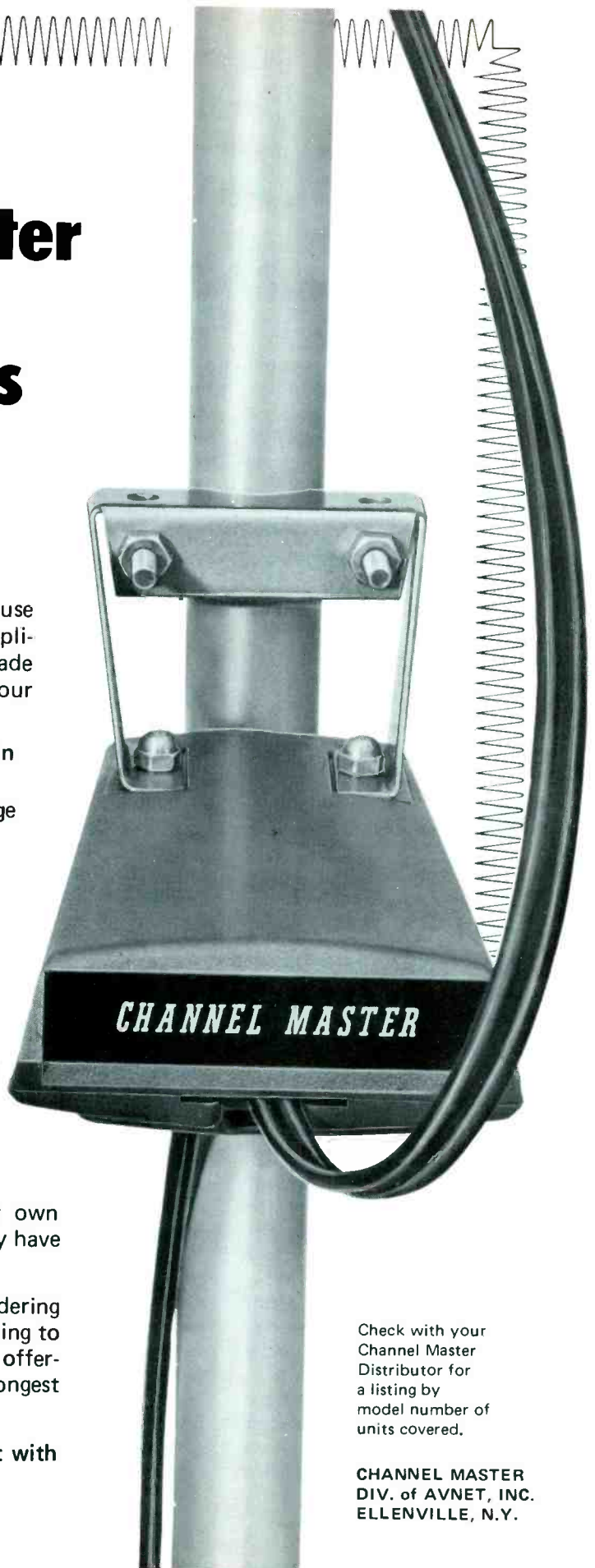

Check with your Channel Master Distributor for a listing by model number of units covered.

**CHANNEL MASTER
DIV. of AVNET, INC.
ELLENVILLE, N.Y.**

For More Details Circle (10) on Reply Card

es (Figure 1), but there was no improvement. Therefore, we had the chassis brought to the shop, where it operated normally for a couple of days.

We increased the line voltage to 130, to speed up the diagnosis, and the breaker tripped regularly. Next, these tests were performed:

- With the power off, the DC supplies were measured with an ohmmeter, but no shorts were found;
- When testpoint "L" (anode of SCR101) was grounded and the power turned on, the waveforms on the SCR102 side of the circuit were normal (Figure 2), and the breaker held. This indicated the defect was in the trace (SCR101) side of the circuit;
- Preliminary tests of the trace circuit found nothing wrong; and
- Capacitor C135 (C6 in Figure 1) was removed for checking on a capacity tester, but the leakage appeared to be normal.

Other components were tested without success, and various line voltages were used. Finally, just because this capacitor has been known to cause similar erratic symptoms, we again removed C135. This time it checked a slight leakage.

After C135 was replaced with a new RCA capacitor, the breaker refused to trip at any reasonable line voltage.

Comments

C135 is not a garden-variety type; its characteristics are rather unique. In normal operation, both sides of the capacitor have waveforms with high peak voltages plus DC, so the internal construction should have no sharp points to trigger arcs. Even so, some defective original capacitors seem to arc internally part of the time, yet don't check leaky out-of-the circuit.

Secondly, the full retrace current of several amperes flows through this capacitor 15,734 times per second. Therefore, the construction must be of a special type to carry such large currents without excessive heating. If you use an off-the-shelf type for replacement, it's almost a certainty it will run hot

and fail in a short time.

Other RCA models use a comparable capacitor, but of a different capacitance and identification number.

#2 Breaker Tripped At High Brightness RCA CTC40 (Photofact 1030-2)

In this case, the dealer's technician had replaced the SCR's and damper diodes while the receiver was in the customer's home. Therefore, it was brought to the shop for a more thorough examination.

Operation at a brightness level only slightly below normal did not trip the breaker, but a higher setting of the brightness control caused the breaker to trip. We tried all the DC voltages and waveforms in the sweep circuit, but found no abnormalities. Also, there were no signs of arcs or other disturbances as the breaker tripped.

To speed up the troubleshooting, we increased the line voltage to 130 volts, and this caused the breaker to trip at turn-on regardless of brightness level.

The symptoms now were so similar to those of Case #1 that we replaced C135, and the trouble was over.

Comments

More sweep power must be produced to supply the increased brightness. This extra power flowing through C135 apparently caused a momentary short (or arc) which activated the circuit breaker.

#3 "Christmas Tree" And Breaker Tripped RCA CTC48 (Photofact 1300-2)

Another service shop brought this chassis to us for repairs. I connected it to our test jig using the proper adapters, and the trouble was verified. At turn-on, the screen would show flashing lines, and high-pitched sounds could be heard from the sweep section. Then after a few seconds, the breaker would trip.

I assumed, since someone else had been working on the receiver, that all normal preliminary tests and replacements had been made, and that was my mistake.

In this chassis, the HV Hold-down (disable) circuit detects excessive yoke current and operates to throw the horizontal oscillator far out of lock. I grounded TP2 (Figure 1) to defeat the disable function, but it did not help.

The next step was to turn off the power, attach a jumper wire from terminal "L" to ground, then restore the AC power. Amplitude and waveshape of the signal at the anode of SCR102 (point "R") were normal.

This suggested that the trouble was in the trace side. I replaced SCR101, CR1, and C6, and checked for excessive high voltage. No change of symptoms occurred. I disconnected C3, C7, and C122, but there was no improvement.

Further tests required continuous operation, so I reduced the line voltage to 75. Now, the breaker would not trip, sound was present, but the raster was narrow, dim, and out of focus. After careful adjustment of the screen controls (to increase brightness), fine tuning, and horizontal-hold control, I finally could see the oscillator was far out of frequency.

I installed a new MAH-1 horizontal-oscillator module and the set worked okay.

Comments

Never take for granted that the technician ahead of you has followed all the recommended preliminary tests, including the replacement of modules in the affected circuit.

#4 Breaker Tripped When Hold Control Was Adjusted RCA CTC48 (Photofact 1300-2)

The symptoms were somewhat similar to those of Case #3. Adjustment of the horizontal-hold control would cause breakup of the raster into random lines, then the breaker would trip. It appeared either that the oscillator was unstable, or something was breaking down intermittently. This tentative diagnosis was verified partially by nearly-normal operation at 75 volts of AC power.

27 INDISPUTABLE REASONS FOR USING DATA TECHNOLOGY'S HANDHELD DIGITAL MULTIMETER—FREE FOR TWO WEEKS.

1. FREE TRIAL OFFER

Data Technology's Model 21 is unique. There's no question about it: a palm-sized 3½ digit DMM that measures capacitance along with AC and DC volts and resistance. Send for the Model 21 now and use it daily in the field or at your bench. Carry it around, knock it around, use it hard, work it long, and if at the end of two weeks you don't think it's worth the \$269.00 we're asking, send it back. And you won't spend a dime.

2. DELIVERY WITHIN 14 DAYS

We understand. Once you've decided you want an instrument, especially a piece of equipment as new and exciting as the Model 21, you don't want to have to go through the old, tedious, inquiry run-around. Mail in the coupon. Before fourteen days have passed, you'll be using your Model 21.

3. SMALL LIGHTWEIGHT PORTABILITY FOR HANDHELD OPERATION

What do you need in a portable DMM? How about a palm-sized unit that fits comfortably in your hand? We've fit all of the range and function features you wanted into a package that slips into a pocket. Only 12 ounces in a case 6.80 inches by 3.25 inches by 1.75 inches.

4. UNIQUE CAPACITANCE READINGS



Model 21: Only handheld portable DMM to measure capacitance.

Data Technology's Model 21 is the first, and only, handheld digital multimeter to give the capability of measuring capacitance, along with AC and DC volts and resistance. Two meter capability for the price of one.

5. MOMENTARY OR CONTINUOUS ACTION



Battery charge life is conserved by push-to-read switches on the case side and optional push-to-read probe. For a hands off "ON" state, slide the push-to-read switch into its "locked-on" position.

6. 0.270 INCH LED READOUT

Immediately and easily visible whatever the light conditions, not like reflective liquid crystals, or small LEDs. In a digital multimeter, what could be more important than an easy-to-read display?



7. 3½ DIGITS FOR FULL 2000 COUNT

8. FLASHES OVER RANGE

The last three digits flash automatically when you are out of range. No reading errors due to the wrong range.

9. IMPACT RESISTANT

Rugged construction, inside and out, absorbs physical shock. It'll get dropped. And banged. But, anytime, anywhere your work requires, it'll keep working.



10. ACCURACY

Here are accuracy comparisons between the Model 21 and its volts and ohms competitors, the HP 970A and the Danameter. We offer this comparison because we know variety of function and range is important, but accuracy is crucial. There are four Model 21 ranges for each function. DC voltage: 2V, 20V, 200V, and 1,000V. AC voltage: 2V, 20V, 200V, and up to 1,000 peak. Resistance: 2KΩ, 20KΩ, 200KΩ, 2,000KΩ. Capacitance: 2nFd (2,000pFd), 20nFd, 200nFd, and 2,000nFd (2μFd).

11. USE YOUR CREDIT CARD OR P.O. NUMBER

Just fill in BankAmericard, MasterCard or P.O. number, and give us your signature authorizing charge. In 15 days, when you're a happy man, we'll submit an invoice. Or you can include a check or money order with your order.

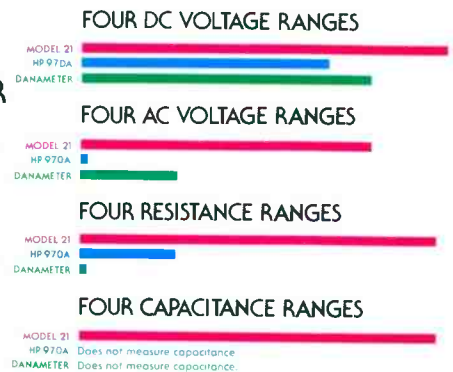

12. \$525 SPECIAL DEAL (SEE COUPON)

13. JUST FILL IN SELF MAILER BELOW

Pick up a pen or pencil and get started, so that we can send you a Model 21. But, if you're still not convinced, our strongest kickers are yet to come.

Name _____

Company _____

Address _____

City _____ State _____ Zip _____

- Send a Data Technology Model 21 for \$269* If I am not completely satisfied, I may return the Model 21 within 15 days and owe nothing.
- Recharger: 100V 115V 230V
- Two of us would like to order Model 21's, so pass the savings on. Two Model 21's for \$525; save \$13.00. That's special.
- I'd like the push-to-read option for \$10.
- I'll take a high voltage probe for \$15.
- Data technology's product line sounds interesting. Send me additional literature on these product lines.

I prefer to be billed: MasterCard BankAmericard P.O.
Your credit card or P.O. Number: (Include four digit bank number if MasterCard) _____

Signature (please sign here) _____

*State and local taxes, if any, will be added

 data technology corporation

14. SPECIFICATIONS COMPARABILITY

Okay, for all of you who have been saying, "Enough words, show me the facts." Here they are.

	MODEL 21	HP 970A	DANA 2000
D.C. VOLTS			
Ranges	2V 20 200 1000	1V 1 10 100 1000 (500 max)	2V 20 200 1000
Resolution	1mv	100uv	1mv
Input Protection	1000V	1000V	1000V
Accuracy	±(0.1% Rdg + 0.5% F.S.)	±(0.7% Rdg + 0.2% F.S.)	±(0.5% Rdg + 0.5% F.S.)
Polarity	Auto	Auto	Auto
Input Resistance	10 meg	10 meg	10 meg
NMR	2V to 20V Range 30dB @ 60Hz All others 18dB @ 60Hz	Not Specified	50dB @ 60Hz
Temperature	± 0.1%/°C Rdg ± 0.02%/°C F.S.	± 0.5%/°C Rdg ± 0.02%/°C F.S.	Not Specified
Input Current	± 7na max	Not Specified	Not Specified
A.C. VOLTS			
Ranges	2 20 200 1000 (pk)	1V 1 10 100 1000 (500 max)	2V 20 200 1000
Resolution	1mv	100uv	1mv
Input Protection	1000V peak	1000V peak	1000V peak
Accuracy	All Ranges 50 to 500Hz ±(0.5% Rdg + 0.1% F.S.)	1V to 1000V 45 to 1KHz ±(2% Rdg + 0.5% F.S.) 1V (>3mv) Range ±(2% Rdg + 0.5% F.S.) 1V to 1000V 1KHz to 3.5KHz ±(3% Rdg + 0.5% F.S.) 1V (>3mv) Range ±(5% Rdg + 0.5% F.S.)	All Ranges to 5KHz ±(1.5% Rdg + 1.5% F.S.)
Response Time (5 Volt step)	<3 sec	Not Specified	Not Specified
Temperature	± 0.3%/°C Rdg ± 0.1%/°C F.S.	±(0.05% Rdg + 0.05% F.S.)/°C	Not Specified
Input Impedance	10 meg in parallel with 40pf	10 meg in parallel with 30pf	2 megohms
OHMS			
Ranges	2KΩ 20K 200K 2M	10KΩ 100K 1000K 10,000K	200Ω 20KΩ 2MΩ 200MΩ
Resolution	1Ω	1Ω	0.1Ω
Input Protection	20V max	(fused) <115V RMS for 1 min <250V RMS for 10 sec	250V RMS or D.C.
Accuracy	±(0.15% Rdg + 0.05% F.S.)	±(1.5% Rdg + 0.2% F.S.)	±(2% Rdg + 15% F.S.)
Response Time	<0.3 sec	Not Specified	Not Specified
Temperature	± 0.02%/°C Rdg ± 0.005%/°C F.S.	±(0.05% Rdg + 0.02% F.S.)/°C	Not Specified
CAPACITY			
Range	2nFd 20 200 2000	Does not measure capacitance	Does not measure capacitance
Resolution	1pFd		
Accuracy	±(0.15% Rdg + 0.05% F.S.)		
Internal			
Capacity Offset	4pFd		
Temperature	±(0.15%/°C Rdg + 0.005%/°C F.S.)		
Input Protection	20V max		

15. FLIP-UP STAND

16. BATTERY OPERATED

When operated in push-to-read mode, the internal NiCad batteries provide typically more than 2,000 readings from the rechargeable battery pack.

17. SELF-CHARGING

The internal battery pack recharges overnight. Please specify 100, 115, or 230 volts when ordering your Model 21.

18. HANDY BELT CARRYING CASE

Included as standard equipment.

19. CONSTRUCTED FOR FIELD CONDITIONS

Out in the field there's nothing to worry about; it's constructed for the toughest conditions. Yes, Data Technology's Model 21 had to be small, portable and multi-talented. But, what good would all that be if it was temperamental?



20. SOLID STATE SINGLE BOARD, STANDARD COMPONENTS DESIGN

Inside the high impact polycarbonate case, the Model 21 uses a single PC board that performs to your highest expectations with the fewest components. All components laid down to withstand impact, shock and abuse.

21. FIVE STEP SIMPLIFIED CALIBRATION

Only 1 adjustment for each function, plus a zero adjustment. It's less than a 15 minute job, first time.

22. HIGH VOLTAGE PROBE OPTION

If you take high voltage readings, an extra \$15 will extend your Model 21 voltage measurement capabilities to 30,000 volts.

23. PUSH-TO-READ PROBE

For an extra \$10, we'll include a push-to-read probe. Standard test leads are provided free.



24. BUILT BY DATA TECHNOLOGY CORP.

25. 1-YEAR FACTORY REPAIR

Data Technology Corporation warrants that every Model 21 Digital Multimeter meets its published specifications before it is shipped from the factory. The Model 21 is warranted against defects in materials and workmanship for a period of one (1) year from the date of delivery.

26. COST: LOW PRICE FOR PERFORMANCE

We can't help repeating ourselves: at \$269.00 it's like receiving two digital meters for the price of one. You get AC and DC volts and resistance measurement, just like our competitors offer, plus capacitance measurement. At a great price: \$269.00.

27. READY TO MAIL. WON'T COST YOU A STAMP



By now, you've filled your order coupon on the other side of this page. Okay. See the self-mailer below? Tear out this sheet on the perforations, and fold it into thirds with address on the outside. Staple it. If you've included a check or money order, also staple both ends. Drop this mailer in the mail box. Now wait. You'll be receiving your Model 21 within 14 days.

FIRST CLASS
PERMIT NO. 4314
SANTA ANA, CA. 92704

Business Reply Mail

No postage stamp necessary if mailed in the United States

Data Technology Corporation
2700 Fairview Road
Santa Ana, California 92704



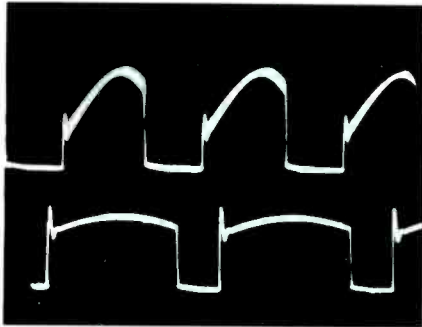

Fig. 2 Trace at the top is correct waveform for point "R", while bottom trace shows the lower frequency and changed waveshape when point "L" is shorted to ground as a test. The frequency decreased because of the disable circuit.

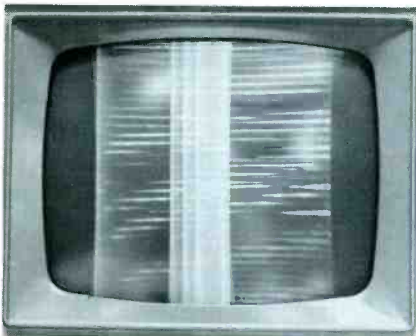

Fig. 3 An open L1 produced this out-of-frequency, narrow raster with foldover.

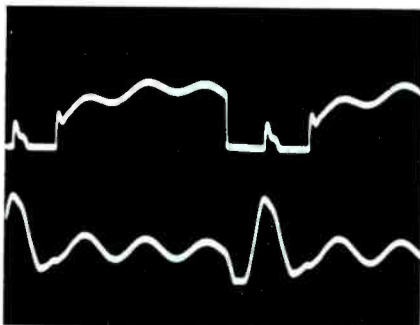

Fig. 4 Top trace is the anode waveform of SCR102, and the bottom trace shows the anode signal of SCR101 when L1 was open.

I substituted the horizontal-oscillator module, MAH-1, but the trouble persisted, so I placed the original module back in the chassis. Next, both SCR's, both damper diodes, and C6 were replaced one at a time, without any improvement when the line voltage was returned

to 120. After the trouble would start, the waveforms were a jumbled mess that made proper diagnosis impossible. The job seemed hopeless, for all the likely components had been substituted already.

After a coffee break to change the trail of thought, I again tried component substitutions, but this time **all** the new components were left in the set until normal operation was obtained. Then the new ones were removed **one at a time** and the originals installed, with the performance checked after each change. Briefly stated, the end result was finding that **both** SCR101 and the horizontal module MAH-1 required replacement at the **same time** to correct the trouble.

Comments

Double defects call for reversing the usual procedure of parts and module substitutions. Install **all** new ones, then put back the old components one at a time until the trouble occurs.

#5 Narrow, Flashing Raster, Then Breaker Trips RCA CTC48 (Photofact 1300-2)

Another dealer brought an RCA table model to our shop because the recommended field procedure had not helped.

Erratic scanning lines and squealing noises from the sweep components indicated a wrong horizontal frequency.

I remember the previous time I had wasted hours because another technician had not performed all the field tests, so I went through the whole list.

To eliminate the possibility that a loss of HV regulation had activated the disable circuit, I grounded TP2. The symptoms did not change, but within a few seconds R25 started to smoke, something that does not usually happen when TP2 is grounded. I hurriedly removed the ground.

With point "L" grounded, the waveform and amplitude at the anode of SCR102 (point "R") was normal, directing suspicion to the trace side. Line voltage was reduced to 95 to permit operation without tripping of the breaker. That per-

mitted a narrow raster with fold-over in the center to be observed (Figure 3). **A similar raster display might be caused by an open SCR101 or CR1 diode; however, the new ones didn't help.**

DC voltage at TP1 measured 104 volts, which explained why R25 overheated when TP2 was grounded. Damped wavetrains were found at the anodes of both SCR's (Figure 4). This suggested that either SCR101 or CR1 was not conducting. However, both had been replaced without any improvement.

Suspicion was aroused about the drive for SCR101. Only .3 volt of drive whose waveform had extra pulses and ringing was found at the gate of SCR101 instead of the usual 35 volts p-p. **Coil L1 proved to be open**, and replacement cured the problem. Figure 5 shows the series of waveforms from T1 to the gate of SCR101.

Comments

The correct operations of both retrace and trace circuits depend on proper control (damping) of ringing. Without conduction of the SCR's and damper diodes, only damped wavetrains would result. Analysis of these waveforms can be very important in obtaining a proper diagnosis.

#6 Breaker Tripped At Turn-on When Set Was Cold RCA CTC48H (Photofact 1300-2)

This receiver operated so strangely that the dealer brought the entire set to my shop. When the power was first turned on, the circuit breaker tripped instantly. However, the breaker could be reset and the receiver would operate fine all day long.

At first, I thought temperature was the determining factor. But further tests showed the chassis had to be turned off two hours or more before the breaker would trip at turn-on. The critical factor was time, not heat.

Because of the two-hour wait to find if a component replacement helped or not, I replaced more parts each test than is my usual custom. The power-supply module was changed, all B+ lines checked for leakage, and all the usual

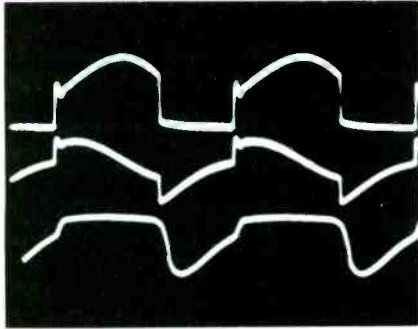

Fig. 5 Top trace is the normal one at the junction of T1 and C4. Center trace shows the tilted waveform at the junction of C4 and L1, and the trace at the bottom is the normal waveform at the junction of L1 and R4 (gate of SCR101).

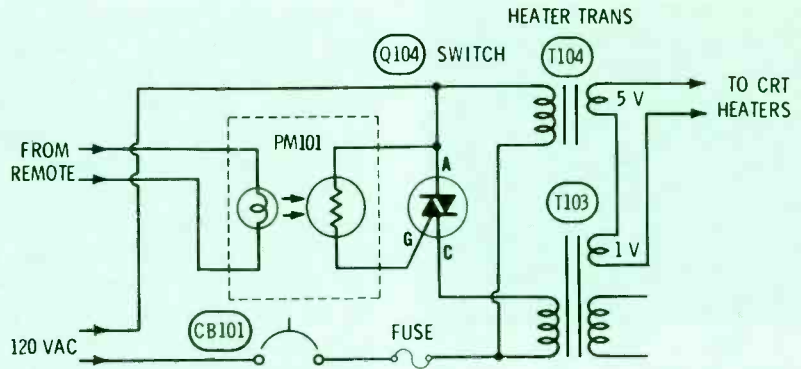

Fig. 6 This partial schematic shows how the triac acts as an on/off switch supplying power to the power transformer. A shorted triac would prevent turning-off the set, and an open one would stop sound and picture.

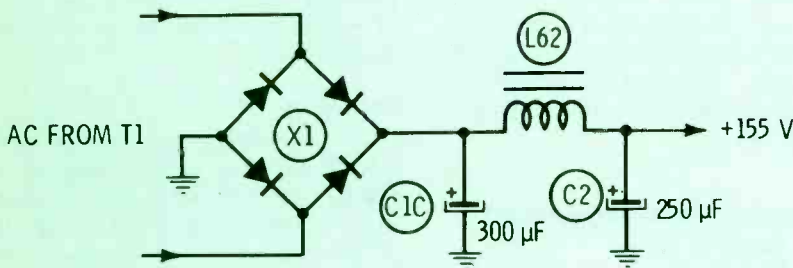

Fig. 7 An open C2 can increase the signal ripple on the +155-volt supply so the breaker trips occasionally.

substitutions made in the horizontal-sweep circuit, but the trouble continued.

To determine whether the problem was in the vertical or the horizontal, I connected one voltmeter to the anode of SCR102 and another to the +80 volt line that supplied the vertical sweep. At turn-on, the +80 volts was present instantly, but only a low voltage was at the SCR before the breaker tripped. When the breaker was reset, the full +155 volts appeared immediately. This proved the trouble was in the horizontal circuit.

Next, I noticed that a few volts remained at the +155 volt line after the set was turned off. Could this residual voltage be the reason the horizontal would start normally the second time?

After some thought, I decided to discharge one capacitor each time the set was turned off. The hope was that when the critical area was bled of voltage, the breaker would trip at the next turn-on. Finally, this happened after I discharged C18, which is in the HV hold-down circuit. C18 tested okay, so all the resistors in the hold-down circuit were checked. R24 was found to be about 300 ohms instead of the correct 3,300 ohms. Replacement of R24 solved the turn-on problem.

Comments

It's not clear exactly why the wrong value of R24 caused the breaker to trip whenever C18 had no stored voltage. One guess is that the residual voltage left in C18 reverse-biased CR8 (at least for a time), thus opening the path bet-

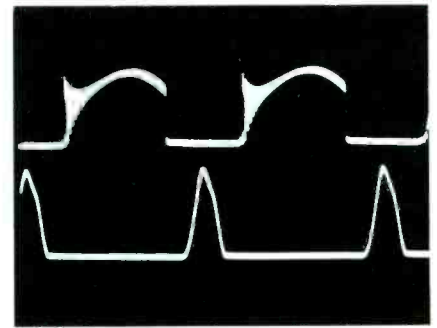

Fig. 8 Top trace is the waveshape with ringing at the anode of SCR102 when C122 or R126 was open. Waveform at the anode of SCR101 (bottom trace) was not affected very much.

ween the oscillator and the flyback transformer. But when lack of voltage unblocked the path, parasitic oscillations occurred which kept SCR102 conducting too long, acting as a B+ short. **It is known that a shorted CR8 will cause the breaker to trip at turn-on.** However, in that event, it trips regardless of how long the power has been off.

#7 Breaker Tripped At Turn-off RCA CTC48 with remote

These remote models use a triac as an on/off switch. Triac's are about like two SCR's of reversed polarity connected in parallel, so that current flows during both halves of sine waves when the SCR is triggered by a voltage at its gate. As shown in Figure 6, the remote control circuitry (or the front-panel switch) lights the in-

candescent lamp in PM101 photo-optical isolator. The light causes the cadmium-sulphide cell to decrease resistance, biasing-on the gate of the triac, and the triac in turn conducts voltage to T103.

After some tests and false starts, I replaced the triac, and the problem was solved.

Comments

If for a test, a DC voltage supply and a potentiometer are used to trigger a triac, a critical bias sometimes will be found where the triac passes current only during half cycle (like a diode or SCR). Above this critical bias voltage, the triac conducts during both polarities of sine waves.

Evidently this one particular triac had a broader plateau where the diode effect occurred. Why didn't it trip the breaker during turn-on? For that answer, we need to consider two characteristics of cadmium-sulphide cells.

When a cadmium-sulphide cell first is illuminated, the resistance decreases rapidly. But when the lamp is turned off, the change to higher resistances is much slower. Therefore, in this circuit, the triac is turned on rapidly, and turned off slowly. The slower turn-off allowed

the triac to remain in the half-wave state long enough for the pulsating DC to produce excessive current in the primary of the power transformer, thus tripping the breaker.

#8 Breaker Tripped Intermittently

RCA CTC40 (Photofact 1030-2)

If the recommended in-home procedure of tests and parts replacements doesn't restore normal operation so the breaker doesn't trip intermittently, connect a test capacitor across C2 (Figure 7).

An open filter causes excessive signal ripple on the +155-volt line, sometimes making the breaker trip occasionally.

When C2 is open, the circuit attempts to use C1C as the output filter. However, the current to the filter must go through the choke, L62. In some cases, this current heats the choke enough to make the cover turn brown, and even causes shorted turns. Check the DC resistance; a good choke should measure around 7 ohms.

#9 Breaker Tripped At Turn-on

RCA CTC68A (Photofact 1378-2)

None of the usual preliminary tests helped, so I finally decided to

check the waveforms of this chassis against those of another that was operating okay. Waveforms at the anode of SCR102 and the gate of SCR101 had damped wave trains (Figure 8).

Additional tests showed C122 shorted and R126 open. Evidently, C122 shorted, overloading R126 which opened. Without this damping circuit, the waveform at point "R" had too much ringing, and caused wrong triggering of SCR101.

#10 Breaker Tripped At Channel Change

RCA CTC46 (Photofact 1243-2)

Because the breaker tripped almost every time the channel selector was rotated, at first I believed the mechanical vibration from the tuner was triggering some defect in the horizontal sweep or voltage source. However, tapping on the chassis would not start the problem.

After many tests, I discovered that there was a sharp change of brightness when the channels were changed, and the power in the horizontal-sweep circuit changed accordingly.

Tests by replacing the SCR's and diodes revealed SCR101 as the cause of the breaker tripping.

#11 Picture Had Hum Bending

RCA CTC59 (Photofact 1275-3)

Following a routine replacement of MAH-1 (horizontal-oscillator module), the picture had bending of vertical lines in the picture, but only at high brightness. When the picture was dim, the bending was missing. The effect could be seen more easily on crosshatch pattern.

Of course, open filters and excessive ripple were the first suspects, but all were normal.

Finally, I decided to put the set back together and continue the work at a later date. **After I transferred the shield from the original module to the new one, the picture bending was gone.**

Comments

Evidently the larger CRT current
(Continued on page 59)

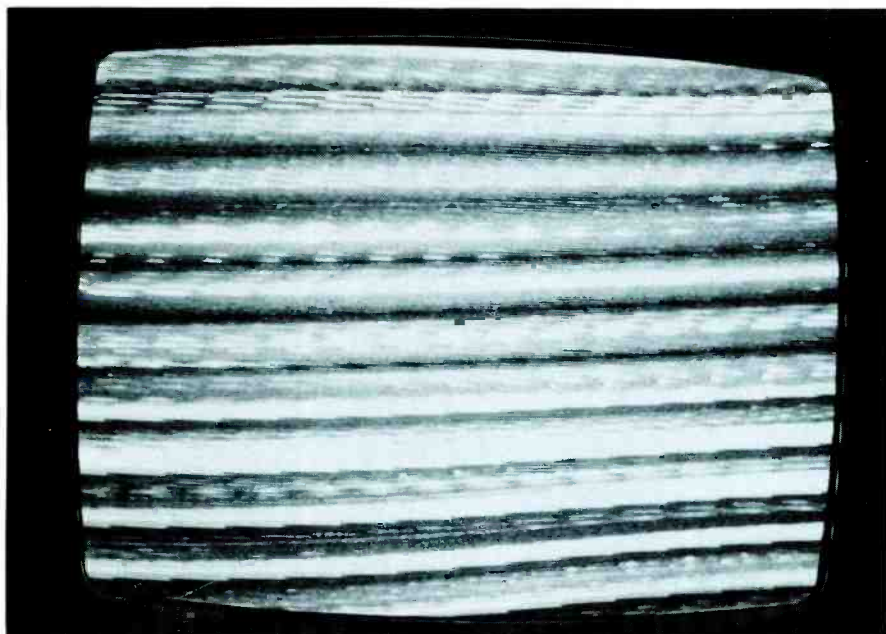

Fig. 9 Many horizontal stripes slanting down to the left resulted from normal action of the disable circuit when the HV regulation was inoperative.

RCA's Free & Easy Dealer Awards

RCA Electronic Components Harrison, New Jersey 07029



**Toastmaster Plug-in Automatic
Timer for Lamps and Appliances**

Cordless timer plugs directly into outlet. Time cycle extends from 90 minutes to 22½ hours. Turns lamps and appliances on or off any time of day or night and repeats the operation every 24 hours without resetting.

FE-630



**Polaroid Colorpack 5 Land Camera
and Kit. Enjoy Instant Photography
in Color and Black and White**

• Big 3¼ x 4¼ color pictures in one minute • Black and white pictures in seconds • 3-element lens and unique face-in-the-square viewfinder

FE-687 Value: \$44.95



Canon Palmtronic LE-83 Calculator

Slender enough to put in your pocket, the Canon Palmtronic LE-83 combines convenience with precision. • Adds, subtracts, multiplies, divides, performs mixed calculations, calculations with a constant and n-th power calculations. • Comes with an AC adapter or can be used with 4 penlight batteries. • Smooth key touch, easy to read LED indication panel.

FE-LE-83 Value: \$44.95



Schick Styling Driers, Man's & Lady's Models

For Women: Quick drying with more natural styling
For Men: Dries fast while it styles and grooms
• 2 Speeds, 2 Heats • Dry setting — high airflow and high heat • Style setting — low airflow and low heat • Professional styling brush and styling comb • Air concentrator nozzle

Man's FE-336 Lady's FE-338 Value: \$15.98



**Spalding "Rebel" Golf Balls
(One Dozen)**

Spalding is the premier distance ball with indestructible Surlyn cover. Two-piece construction gives you extra yards for the power you pack into your drive.

FE-11117 Value: \$14.90

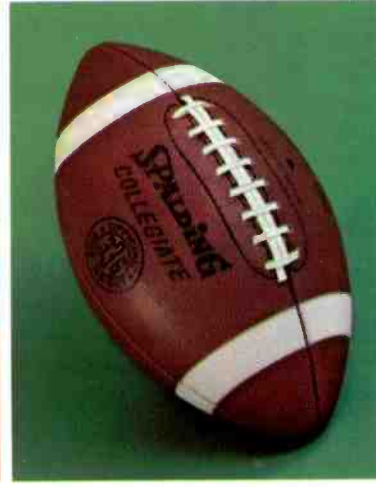

Spalding "Collegiate" Football

The best value you'll find in a full-grain leather football. Tough butyl rubber bladder. Triple fabric lining with lockstitch construction.

FE-61448 Value: \$17.00

When you buy RCA tubes from your participating RCA tube distributor, he delivers the goods the easy way. No muss, no fuss, no constant cutting of carton flaps, no torn cartons on your shelf or in your caddy. Just give your tube order to your RCA distributor and get your premium the free and easy way. The bigger your tube order, the more valuable your gift. So visit him soon and select your Free and Easy RCA award with your purchase of RCA tubes. *(The values are really extra special.)*

**No Muss • No Fuss • No Torn Tube Cartons.
Visit Your Participating RCA Tube Distributor.
Place Your RCA Tube Order
and Select Your "Free and Easy" RCA Award!**

Remember, the Award Values Are Extra Special!



Omaha Steaks Ten RCA "Steak-out '74" certificates can be redeemed for one package of tender, succulent Omaha steaks as follows:
6 (11 oz.) Boneless Strip Sirloins 1 1/8" thick or
8 (6 oz.) Filet Mignons 1 1/4" thick or
8 (8 oz.) Top Sirloins 1 1/8" thick or
6 (8 oz.) Filets of Prime Rib 1" thick
Choice cuts, generous portions and outstanding flavor!
1A2116



BULOVA... The watch you wear with pride. Bulova... synonymous with quality, craftsmanship, precision and style.

Oceanographer — Highly contemporary 17 jewel, automatic instant change day/date calendar; depth tested to 333 feet. **FE-12604 Value: \$110**

La Petite — Stunning feminine timepiece with 23 jewels, 4 diamonds, 10K rolled gold plate case. Adjustable mesh bracelet. **FE-55775 Value: \$110**



Sea King — Stalwart Bulova Sea King, 17 jewel precision timepiece, water-resistant with luminous dial. **FE-12280 Value: \$65**

Concerto — Prettily sculptured model with 17 jewels, 10K rolled gold plate, stainless steel back and silver dial. **FE-63628 Value: \$65**



Compass Binoculars

Perfect for use at the track, at the stadium, in the woods. Field of view is a large 367 Feet at 1000 yards. Hard-coated optics. Complete with case and strap.

FE-3022 Value: \$44.95



Shakespeare Deluxe Spinning Combo Balanced Tackle Set

Shakespeare #2210 Marina Green spinning reel, matching Shakespeare SP-160 6' 6" Wonderrod, 200 yards 6-pound monofilament, box of stainless steel hooks and spinning lure. For fresh and light salt-water fishing. **FE-S460 Value: \$42.00**

Spalding Pancho Gonzales "Pro Champ" Tennis Set

Pancho Gonzales "Pro Champ" racket, water-proof racket cover, plus three Pancho Gonzales tennis balls.

FE-531063 Value: \$18.65

Transistor repairs— The hard way



By Charles D. Simmons

Many technicians feel that repairing a solid-state amplifier is not very easy, even with the aid of complete servicing data. Could you locate an elusive defect in an unfamiliar circuit, without a schematic, using only your general knowledge about transistors? This tech did, but found it a frustrating job.

"Okay, you're an electronics man. Let's see you repair this electronic organ!" There wasn't much I could do to squirm out of it. My friend knew I had repaired organs some years ago before I became a TV man. And, after all, I was at the keyboard when the organ went dead. So an evening of music and conversation turned into work.

While I drove home to collect some tools, I reviewed the facts and symptoms. The pilot lamp had blinked several times as I played a selection, and the power went on and off several more times as I moved the AC cable in an effort to

find where the intermittent was located. With my bare hands, I had spread the prongs of the AC plug. Afterwards the lamp didn't blink, but the organ music was very soft and distorted.

Before this trouble, the organ at turn-on hummed audibly, the hum faded rapidly to silence in a fraction of a second, and then the organ could be played. This rapid operation proved the circuits had solid-state components, not tubes.

My snap diagnosis was that a transistor probably had blown because of voltage surges from the intermittent power. Transient voltages are a potential danger to solid-state components.

At my TV shop, I have both a beta tester and a curve tracer for checking transistors. But I operated for years without such luxuries, and I know an ohmmeter will serve quite well in an emergency. So I tossed a few miscellaneous transistors, filter capacitors, tools, flashlight, soldering pencil, and an old VTVM into a cardboard box and returned to the scene of my crime.

Luckily, there were only a few people present to witness my subsequent ordeal. I'm not bashful, but the handicaps of a strange circuit and no schematic would make most anyone feel vulnerable.

Checking Output Transistors

The organ was a Lowrey model TPS (or perhaps a TP3, the plate was up under the keyboard and hard to see). After I removed the back, I was relieved to find the insides were fairly simple. Across the top stretched a dozen oscillator/divider stages, and a couple of other circuit boards. On a brace across the center was a transistorized power amplifier, which drove a 12" speaker.

Under a perforated screen on top

of the chassis were two power transistors. **These were the two prime suspects.** A stamped note said to use silicon transistors, and gave the manufacturer's part number. It was helpful to know they were silicon, although this later was verified in other tests.

Removing the socket screws from just one at a time (keeping them straight in case they might have been part of a complementary pair; that is, one PNP and one NPN), I pulled the transistors out of the sockets and checked them on the ohmmeter. They had TO-3 cases, and I remembered the basing diagram. With the positive ohmmeter lead on the base, I measured about 5,000 ohms (on the X1000 scale) to both emitter and collector. Reversing the probes gave open readings. That's normal for silicon. With the positive probe to the collector and the negative to the emitter, the reading was high, perhaps one megohm. After the probes were cross-switched, the reading was around 1,000 megohms. These readings proved two things: **both transistors were NPN silicon** (germaniums would have given lower readings), and **they probably were not defective.**

Quick DC voltage readings showed (after the transistors were reinstalled) one collector had about +70 volts, and the other about +35. These are normal for a stacked or "totem-pole" type of output stage, in which the common emitters are coupled through a large capacitor to the voice coil of the speaker. Subsequent inspection of the circuit proved this guess to be true.

Bad Driver Transistor

Located near the center of the chassis was another TO-3 power transistor, evidently the driver. Or

was it a regulator? The only way to find out for sure was to pull the chassis and trace the wiring.

Underneath the chassis, several tie lugs supported resistors, capacitors, and one small transistor which was connected to the power transistor. It seemed certain this was the driver transistor.

Only a moment was required to remove the driver transistor. With the negative probe on the base, both the collector and emitter checked about a thousand ohms on the X1000 scale (just about right for a germanium PNP). However, the emitter/collector reading was about zero ohms when checked with both polarities. **Conclusion: it was a shorted PNP germanium power transistor.**

I breathed a sigh of relief as I found a non-defective transistor of those specifications in the junk I had brought.

Unfortunately, the relief was of short duration. After the driver

transistor was replaced, nothing came from the speaker but a loud 120-Hz hum. I removed the transistor, and it checked okay. The original one still checked shorted. But with **either** one in the circuit the results were the same, hum and no music.

Evidently the bad transistor was not the only trouble. Now was the time for some voltage readings and analysis.

Tracing The Circuit

Before the DC voltage readings would be of any help, I had to know more about the circuit. I was glad the wiring was point-to-point on tie lugs, and without circuit boards that would have made tracing more difficult.

Figure 1 shows the circuit as I remembered it later. You see, that was my first big mistake, trying to remember the circuit and voltages without writing them down. With the schematic, you have more

information now than I had then.

The first wrong voltage to catch my attention was the emitter voltage of the driver transistor, Q2. What kind of circuit supplied a power transistor with less than 2 volts of collector/emitter voltage? That had to be wrong. I guessed that the voltage should be between 10 and 20 volts. Why was the emitter voltage so low?

Perhaps C2 was leaking. That would reduce the emitter voltage the same as too much collector/emitter current. However, C2 was okay. When Q2 was removed and the power applied, the emitter voltage shot up high and R5 started to overheat. **This proved excessive transistor current was responsible for the low voltage.**

The next wrong voltage was the forward bias of Q2, which measured -.4 volt from the emitter. That's too high for a germanium (-.2 to -.25 volt would be more reasonable). The base was not posi-

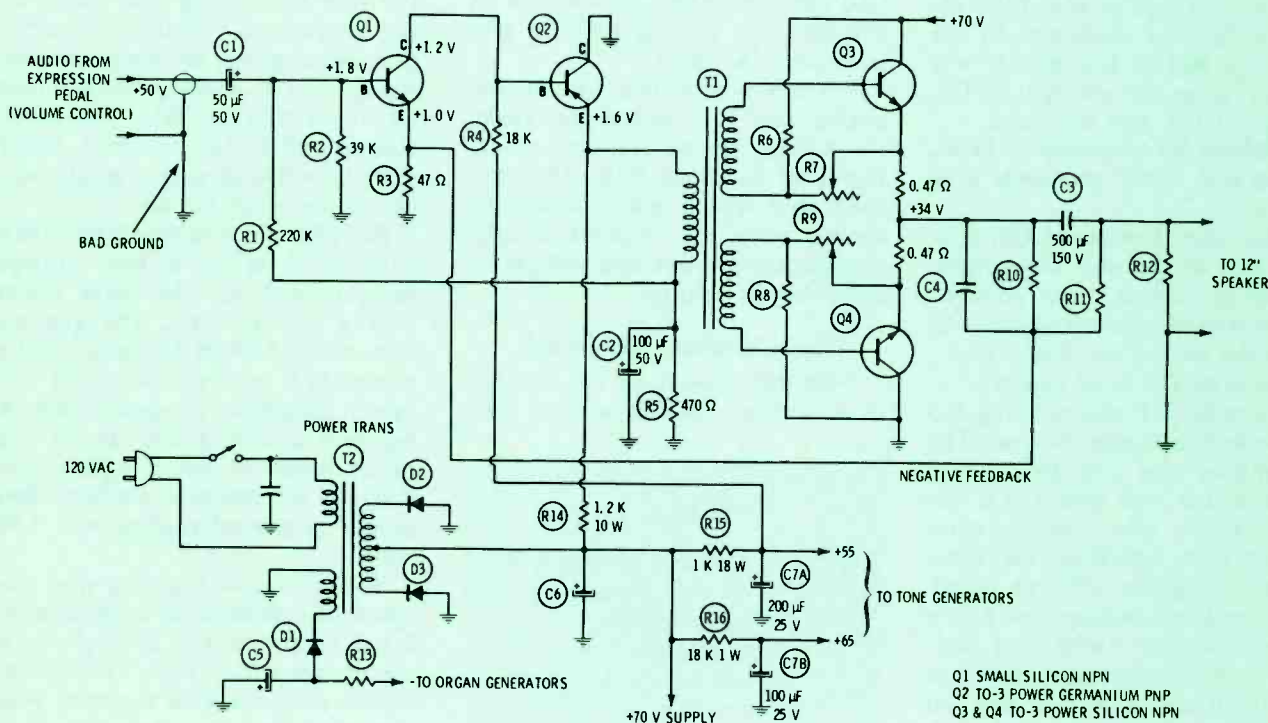

Fig. 1 This is the schematic of the organ amplifier that gave our technician so much trouble. See if you find the defect before he does.

tive enough, measured from ground, and that directed suspicion to Q1, because the collector was directly connected to the base of Q2.

Enough Trouble For One Night

About that time the strain of kneeling on the floor and working blindly without a schematic finally got to me. Of course, it didn't help to have my "friends" offer coffee to wake me up, or to ask in mock concern if I was having trouble. So, I called it a night.

Next evening, I added a few small transistors, two resistance-substitution boxes, and a digital multimeter to my arsenal, and returned to my enemy, the electronic organ.

Another Saturated Transistor

During the day, I had been doing some serious thinking about the symptoms and what they meant. For example, **the original symptoms were distortion and weak volume. Later, they changed to hum and no volume.** I had no idea why the switch.

Analyzing direct-coupled stages can be real hairy. Defects in either stage change voltages and gain in the other. For example, the collector of Q1 was connected to the base of Q2, but the bias for Q1 was obtained from the emitter of Q2. Q1 affected Q2, and vice versa.

Sometimes it's necessary to break the loop and check one stage at a time.

In this case, I removed Q2, connected one of the sub boxes from collector to emitter, and adjusted for the resistance giving about +12 volts at the emitter terminal. Now, I could analyze Q1 more easily.

Apparently, Q1 was drawing too much collector/emitter current. The base/emitter bias was almost +.8 volt, much too high (about +.6 volt would have been reasonable, although each individual transistor demands a slightly different value), and the collector voltage was nearly the same as the emitter. I previously had removed the transistor for testing and found it was an NPN silicon in good condition. While the transistor was out, I measured the base, collector and emitter resistors and found them

within tolerance.

One quick and dirty trick to see if a transistor will turn off is to short the base to emitter. However, the results are somewhat unpredictable in direct-coupled circuits. And there's a chance the test might apply excessive voltages or currents to a subsequent stage. But the second stage here had been disabled, making the test safe.

With the VTVM connected to the collector of Q1, I shorted base to emitter and saw the collector voltage over-deflect the meter pointer on the 15-volt scale. **This was proof the bias was wrong.**

Often it is informative to change resistance values, forcing the transistor to draw the correct current, then analyze why an incorrect value was necessary. So, I connected the other sub box in series with R1 and the supply voltage, and tried values from 15K to 10M. That produced a big surprise, for even an open circuit still permitted a low collector voltage at Q1.

One other component was connected to the base of Q1: the coupling capacitor, C1. The polarity markings seemed to indicate that it had been installed backwards by the factory. Was it leaking and increasing the bias?

When the capacitor was disconnected and R1 hooked up again, the voltage at the collector of Q1 increased to about +16. That test indicated there was something wrong with C1. Unfortunately, installation of a new one still gave a low collector voltage.

What Caused The Hum?

After the episode of the Q1 collector voltage reached a dead end,

TABLE 1

Correct Voltages For Figure 1	
Q1 base	+1.2
Q1 emitter	+.6
Q1 collector	+15
Q2 base	+15
Q2 emitter	+15.3
Q2 collector	0
Input to C ₁	0

my mind started on another detour. I had assumed the hum was caused in some way by the saturation currents through Q1 and Q2. But now with Q2 removed, the hum was there in full force.

Hum sometimes is caused by bad filter capacitors, so I paralleled all the filter capacitors in turn with larger values. When that didn't help, I disconnected them and checked for leakage. Also, I checked the power supply diodes to make sure one was not open, thus changing the circuit into a half-wave one, susceptible to hum. All components were okay.

In desperation, I shorted across the primary winding of the driver transformer, T1, but the hum was still there.

At about this time, I accidentally brushed against the can containing C7A and C7B. It was warm, almost hot. Belatedly, I read the ratings on the label, and compared them with the actual DC voltages. The capacitors were being overloaded by too much voltage. However, that didn't seem to be significant.

When you don't know what to do, keep on doing something, but keep alert. So I thought again about C1. Perhaps something was wrong in the expression (volume) circuitry that was applying too much positive voltage to C1, causing leakage that was over-biasing Q1. The mere thought of trying to trace those circuits without a schematic was nearly too much for me.

But with more foolhardiness than wisdom, I made a few voltage measurements on the main organ wiring. At the time, the ground wire of the VTVM happened to be connected to the chassis of the power amplifier. A spastic jerk of my arm accidentally caused the meter probe to brush against the frame of the generator section. **That ground-to-ground reading was +50 volts!**

Such a freak reading was the cause of considerable head-scratching. I never heard of an organ or a stereo amplifier with two metal chassis not connected together. Was it normal for this organ, or was it the defect for which I was searching?

(Continued on page 48)

CHANNEL MASTER PUTS GREAT RECEPTION TO THE TEST!

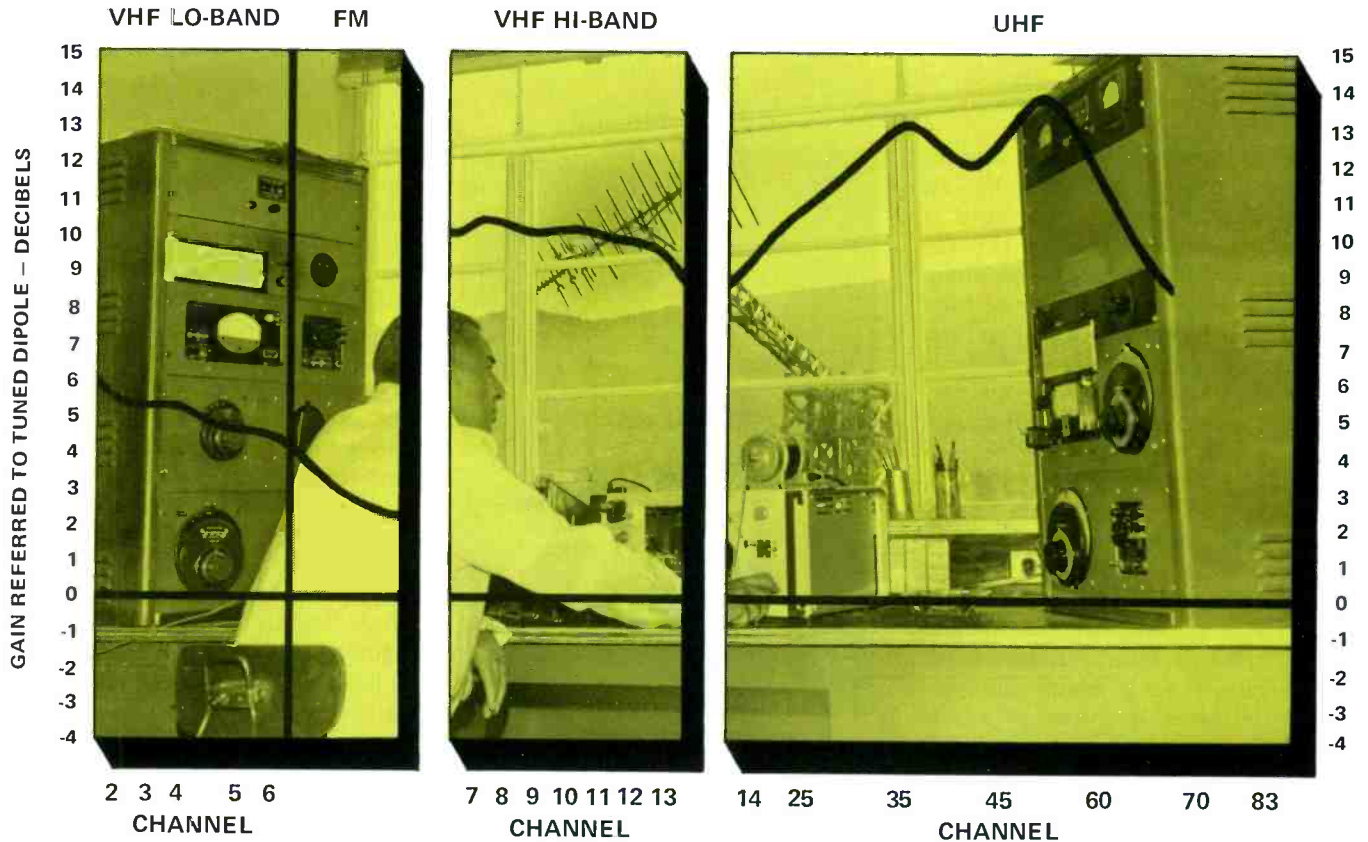

With the Ultra Hi Crossfire--engineered with the performance that's made the Crossfire Series the world's most powerful and popular antenna--plus a retuned UHF section that delivers constant high gain across the band.

When tested against all other antennas of comparable size and element count, the Ultra Hi Crossfire proves its high standing by outperforming all others--in all critical gain areas! No other antenna in its category can approach the Ultra Hi Crossfire's combined UHF and VHF performance.

Ruggedly engineered with extra heavy duty elements and tough construction, the Ultra Hi Crossfire has the guts to stand the test of the worst wind and weathering conditions possible.

Your Channel Master Distributor has actual results--see for yourself how the Ultra Hi Crossfire stands the test of great reception --and comes out on top of its class!

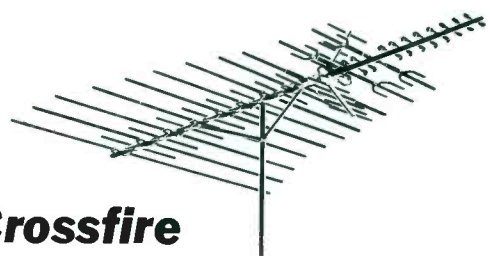

Channel Master Ultra-Hi Crossfire

Avoid the traps of un-needed picture-tube replacements

By Carl Moeller

The most expensive single item in a color TV is the picture tube. To make matters worse, changing it is difficult, and setting up the replacement tube is time-consuming. For all these reasons, a picture tube should not be changed until you are reasonably certain that it really is at fault. It's embarrassing and expensive to change the picture tube, only to find that the trouble persists. Most of these sorry experiences can be avoided if you understand the modes of picture-tube failure, and the methods for determining if a tube has failed.

With the exception of broken glass, there is almost always some other chassis fault which will produce the same symptom as a picture-tube fault.

"Dirty Face"

This is a relatively-new symptom associated with the "super-bright" picture tubes. There are variations in the way this high brightness is obtained, but all the various makes have one thing in common: the phosphor dots are surrounded by black material. The black material absorbs ambient (room) light, thereby increasing the usable contrast. Because the black material absorbs ambient light, the manufacturer can use faceplate glass with greater transparency, producing a brighter picture. But, when the set is turned off, this highly-transparent faceplate allows some of the internal black material to show through.

There is no "fix" for this trouble, since it is not really a fault; "dirty face" is inherent in these tubes. Not all of them have the same degree of "dirt"; some have practically none.



The only way to handle the complaint is to explain that this is the **normal** appearance of the tube. We heard of an instance where five picture tubes were installed in an effort to "find one that wasn't dirty". It didn't work. Obviously, the servicing dealer would have been ahead if he hadn't sold the instrument in the first place. Better still, a factual explanation of the phenomenon probably would have satisfied the owner.

Not to be confused with the situation just described is an actual ring of dirt on the picture tube. This can be caused by a dirty suction cup used to handle the tube at the factory. Such dirt can be removed by thorough cleaning.

Moire

The combination of the newer, high-resolution picture tubes and

wide-band video amplifiers can cause excessive moire. Sometimes a picture-tube change is the only solution, but this does not always do the trick.

Changing the CRT should be the last resort. Try adjusting the height and/or linearity. Also try slightly rotating the yoke. If a video peaking control is used in the instrument, check its effect on the moire and instruct the owner.

There is an erroneous opinion among many technicians that maximum peaking should produce the "best picture". If this were true, there would be no reason for the control. A peaking control in the video amplifier is equivalent to the tone control of an audio amplifier. Both should be adjusted for most pleasing performance, rather than to some arbitrary operating point, such as maximum peaking or full treble.

Purity

Loss of purity can be caused by many things. Within the picture tube, a change in the position of the shadow mask is one possibility. Distortions of the glass over a period of time is another. Both of these are rare. If either of these is ruining the purity, a picture-tube change is necessary. On the other hand, if any of the faults described below is causing loss of purity, changing the CRT will be a waste of time.

Either the shadow mask or the TV chassis can become so magnetized that the automatic-degaussing circuit can not demagnetize it. Turning off a degaussing coil while it is close to the CRT will magnet-

ize the shadow mask. A high-wattage soldering gun can magnetize anything. A thorough degaussing will solve these problems.

TV sets and color picture tubes can become magnetized in transit or in storage. If the picture tube has been stored adjacent to a large electric-service panel, or if an arc welder has been used near stored tubes or receivers, enough magnetism may be induced to affect purity.

Degaussing Defects

A frequent source of purity trouble is the degaussing circuit itself. Figure 1 shows a very popular type of automatic degausser. At turn-on, the AC from the transformer to the bridge rectifier passes through the degaussing coil and demagnetizes the shadow mask. After warm-up the coil is bypassed by the operation of the thermistor and varistor.

Open one diode in the bridge and it becomes a half-wave circuit. The current through the degaussing coil is changed to **pulsating DC** (Figure 2). The DC component of this current actually magnetizes the shadow mask instead of demagnetizing it.

The open diode causes the B+ to drop slightly (about 10%), and the ripple voltage to increase. However, the symptoms produced by these changes in B+ may be so subtle that they go unnoticed.

Figure 3 illustrates the degaussing circuit used by RCA in their modular, solid-state TV's. At turn-on the bridge is unbalanced, and an AC current surge through the degaussing coil demagnetizes the shadow mask. Current flowing through the thermistor causes it to heat, and the warmer it is the higher the resistance. When maximum temperature is reached, the bridge is balanced and there is little voltage or current to the degaussing coil. Of course, an incorrect hot resistance of the thermistor will prevent the bridge from balancing, and the residual current through

the degaussing coil will give an impure raster.

To verify the operation of either of these types of degaussing circuits, disconnect the internal degaussing coil and carefully demagnetize the instrument with a service-type degaussing coil. If purity becomes okay, trouble-shoot the degaussing circuits.

Convergence

If a picture tube cannot be con-

verged, it might be faulty, or there might be several other causes. To begin, check the mechanical convergence and purity adjustments. Be sure that the convergence coils are properly positioned over the pole pieces of the gun. This is especially important if the original picture tube has been replaced. The neck length or gun length of the replacement tube may be different from the original.

Value changes of the components

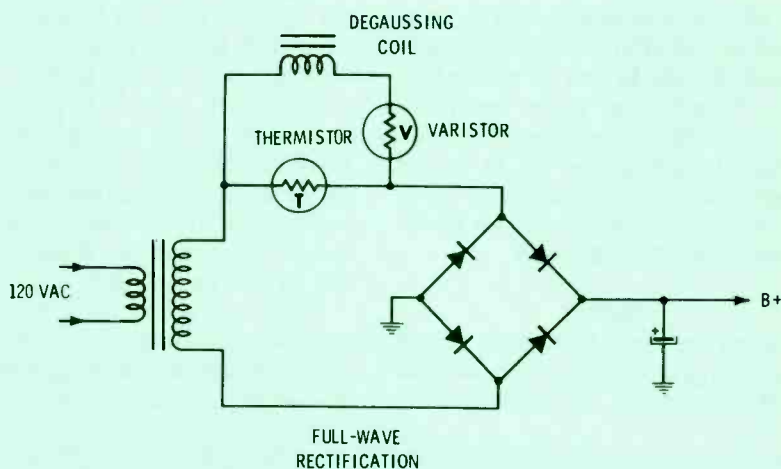

Fig. 1 A typical older degaussing circuit. At turn-on the thermistor is about 120 ohms, so most of the capacitor-charging current flows through the degaussing coil and the varistor. Voltage drop across the thermistor causes it to heat and reduce resistance. This reduces the current through the degaussing coil, and the varistor (because it has less voltage across it) increases resistance to further reduce the current. At maximum temperature, the thermistor has only 2 or 3 ohms resistance, and because of varistor and thermistor actions the current through the degaussing coil is nearly zero. Degaussing takes place each time the receiver is turned on from a cold start.

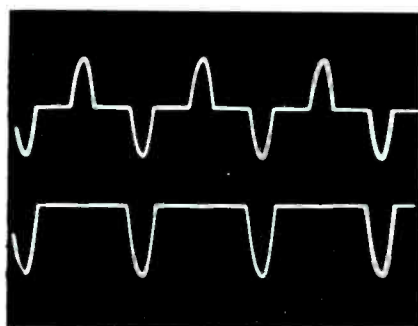

Fig. 2 Waveform at the top is normal for degaussing current when the rectifier circuit is a full-wave bridge. The pulses are opposite in polarity and equal in amplitude, so the degaussing is just as effective as with sine waves. When a bridge diode opens, the current (bottom waveform) is not symmetrical, and actually magnetizes the picture tube.

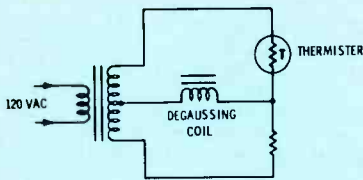

Fig. 3 This degaussing circuit included in some RCA modular-TV receivers uses 60-Hz sine-wave power in a bridge circuit. The two transformer windings are two of the legs, and the two resistors are the other two. At turn-on the thermistor is low in resistance (positive temperature coefficient), and degaussing current flows through the coil. After the power has heated the thermistor, it and the fixed resistor are about the same resistance, the bridge is balanced, and degaussing current is nearly zero.

on the convergence board will naturally affect convergence; so will a broken core in one of the inductors. Insufficient drive from the vertical output tube is possible even though height is normal. It is less likely that convergence drive from the horizontal system will be insufficient if width is normal.

Spots

Spots in the raster can result from plugged holes in the shadow mask, or flaking of the phosphor

dots. This fault is more likely to be encountered in new picture tubes, and a warranty claim will probably be involved. Be certain that the warranty claims are complete and specific to avoid problems with the distributor and manufacturer.

Sometimes an obstruction in the shadow mask or a short between gun elements can be dislodged without a lot of difficulty. Turn the receiver down on its face and lightly jar the CRT. **Be very careful not to scratch the faceplate or break the tube.** Obviously, this method is impractical with large consoles and combos, but the same results can be obtained by putting the tube in its shipping carton and jarring it.

Focus

It is possible for a fault within the picture tube to cause loss of focus, but incorrect focus voltage is more likely to be the trouble. Most large-screen tubes, 21V and up, and some of the smaller ones use 4000 to 6000 volts for focussing. Other small-screen tubes require no more than about 1000 volts and obtain focus voltage from boosted B+ or the normal B+.

When measuring focus voltage in the 4 to 6KV range, remember that such voltages can be hazardous. A few meters have a 5KV range,

which is barely adequate for focus voltage; but before using them be sure the test-lead insulation is in good condition. A VTVM, DMM, or VOM with a high-voltage probe is preferred.

In measuring the focus voltage (or any other picture-tube voltage for that matter) be sure the voltage truly is present on the pin of the tube. Opens and shorts can occur in the socket, particularly sockets with built-in spark gaps.

All of the symptoms described before — with the possible exception of focus problems — are more or less qualitative in nature. Thus, one viewer may consider the purity of a certain instrument to be completely unsatisfactory, but another viewer may not even notice it.

When the cause of any of these problems is really the picture tube, warranty often is involved, because such troubles often are caused by rough handling, improper storage, or manufacturing defects—rather than usage or aging. And, since judgement is often involved in deciding if the defect is serious enough to require replacement of the tube, the unwary technician can easily be “caught in the middle” between an unhappy client and a distributor or tube manufacturer.

If you change a picture tube and the customer still isn't satisfied, you might have trouble collecting. If the customer is satisfied but the tube manufacturer insists there is nothing wrong with the old tube, you might have an unwanted picture tube in inventory. To keep everybody happy, talk over the problem with both the customer and the distributor **before** you replace a suspected, in-warranty picture tube.

Brightness

A frequent type of picture-tube failure is a gradual loss of cathode emission and brightness. This can be tolerated until one of two things happens. Either the picture becomes too dim for normal viewing, or one color is so much brighter or weaker than the others that all scenes become tinted. Then it probably is time to replace the picture tube.

Emission depends on four factors, besides the guns themselves.

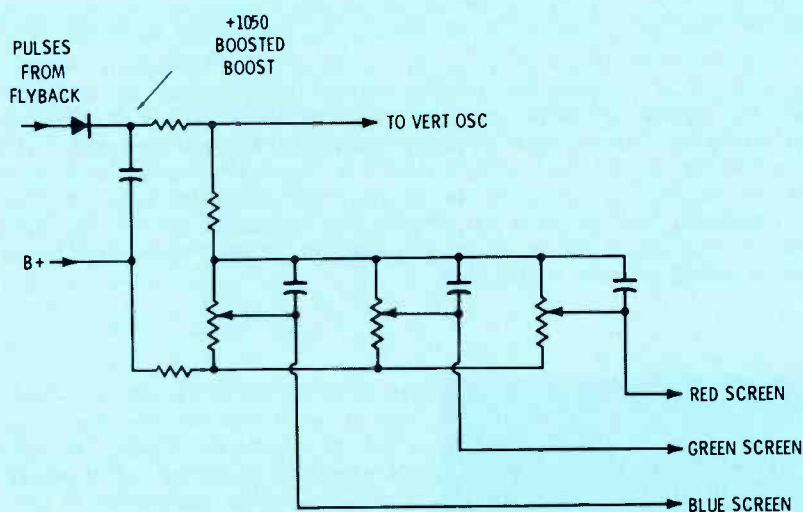
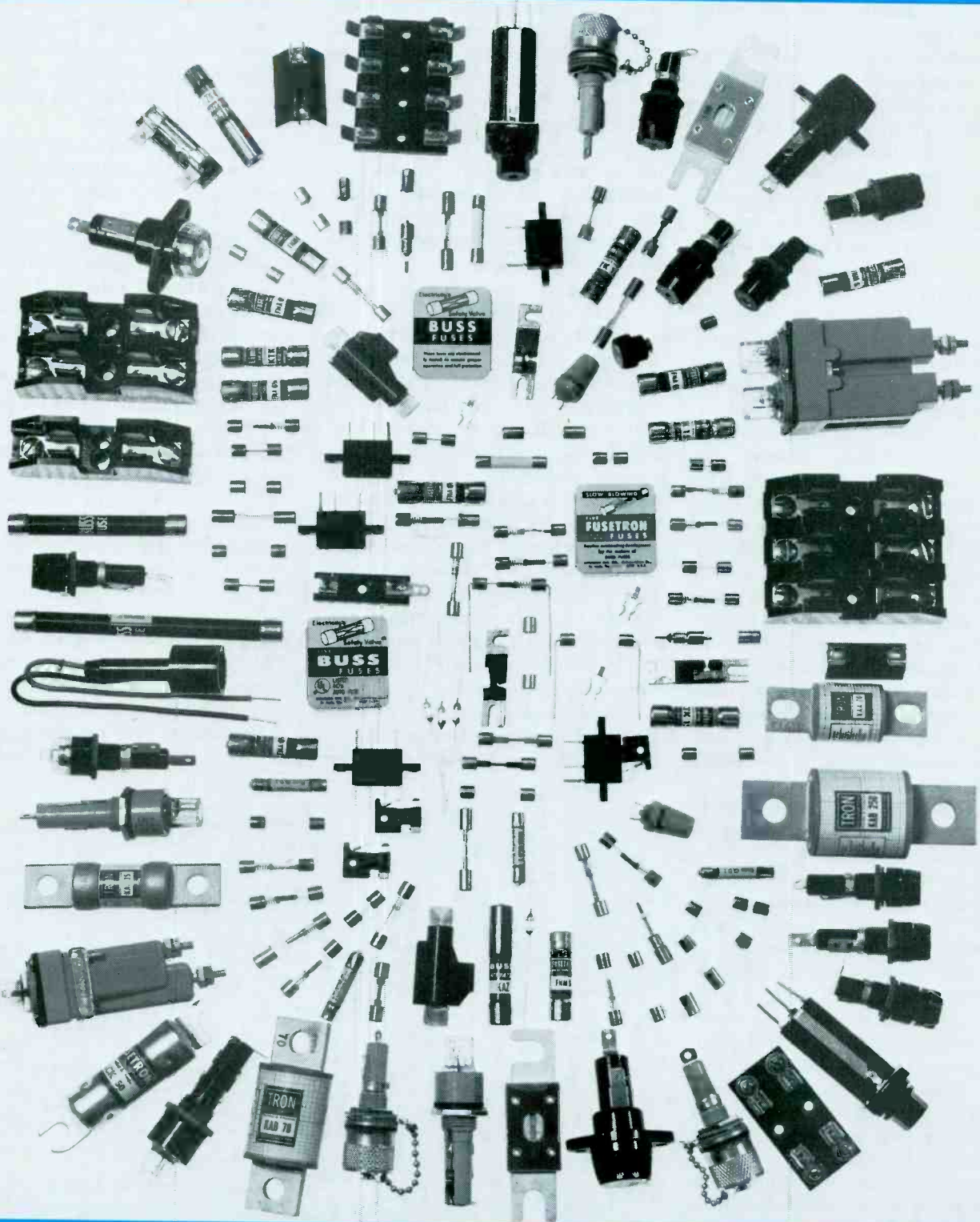

Fig. 4 Some defects in the boosted-boost supply reduce the B+ to both the vertical oscillator and picture-tube screens, causing reduced height and a dim picture. Failure of the screen controls, or the bypass capacitors across them, can produce a tinted b-w screen color.

BUSS®

the complete line of fuses, holders, blocks and clips to protect all electronic and electrical circuits and devices.



BUSSMANN MANUFACTURING
a McGraw-Edison Company Division
St. Louis, Missouri 63107



Insufficient high voltage will cause some loss of brightness, but blooming also is evident. Seldom is a picture-tube failure confused with too-little high voltage.

Insufficient screen voltage will make it impossible to obtain normal brightness. In most receivers, the three screen controls are connected in parallel between B+ and boost or boosted-boost (Figure 4). An open resistor between the controls and the boosted B+ source will make the screen voltage equal to B+, which cannot produce normal brightness.

Complete failure of the boosted B+ supply (or boosted-boost supply, if used) usually results in no vertical deflection. This, of course, is a much more obvious symptom than accompanying reduction in picture-tube beam current. At times, boosted-boost simply will drop to the B-boost voltage. This might not cause failure of the vertical, but it can reduce the maximum height.

Loss or reduction of screen voltage to one CRT gun causes loss or reduction of only one color. This easily can be confused with a weak gun. Before rejecting the picture tube, check the three screen voltages. If the "weak" gun has low screen voltage, chances are good that the CRT is OK.

The control-grid bias is controlled by either a potentiometer or a switched voltage divider, as illustrated in Figure 5. Loss of B+ to the bias control may cause a black raster, or at least a dim one, depending on the circuit design.

As with the screen-grid voltages, all three control-grid voltages normally are about the same. If one is more than 10 volts different than the others, suspect trouble. If one color is weak or missing from the raster, be sure that the control-grid voltage for that gun is at least as positive, as the other two.

The last element voltage (excluding heaters) which seriously affects brightness is the CRT cathode voltage. Several things affect this voltage; among them are the brightness control; the brightness limiter, the emission of the last video amplifier, video-amplifier screen-grid voltage, etc. In solid-state systems there

might be several direct-coupled video stages, and a change in bias of any of them will affect brightness. In some receivers (the RCA CTC24 for one) even the setting of the AGC control will affect brightness.

As with the control-grid and screen-grid voltages of the CRT, if one cathode voltage is greatly different than the other two, suspect circuit trouble. Unlike the grid voltages, an **increase** in cathode voltage decreases brightness.

CRT Testers

The two basic tests performed by a color-CRT tester are measurement of cathode emission with controlled voltages on the cathode, control grid, and screen; and checks for interelement shorts or leakage within the CRT. In these respects, it is similar to an emission tube tester for receiving tubes.

Descriptions of the failure modes of a picture tube make it evident that a CRT tester is not **essential**. If all element voltages are correct and one (or all) of the three guns does not produce adequate light, the tube is defective.

Though it may not be **essential**, the CRT tester is well worth its expense because **it makes simple an**

otherwise laborious troubleshooting job. It takes several times longer to check all the socket voltages and compare them with the service notes than it does to hook up the tester. And this assumes that the voltage data are available, that they are accurate, **and that the allowable variations are known!**

Several testers have provisions for comparing the emissions of the three guns over a range of voltages. This makes it possible to predict how well the guns will track from lowlights to highlights. And that's a test of particular value to the servicing dealer who wants to know the condition of the picture tube in an inoperable trade-in.

Another feature of some testers is the "rejuvenator". Rejuvenation sometimes is accomplished by operating the heaters at above-normal voltage for a period of time, hopefully to reactivate the coated cathodes.

Another rejuvenating system "blasts" the gun elements with high voltage to strip contaminants from the cathode. Unfortunately, it often increases the control-grid aperture. This "blast" also can be used to "burn open" inter-element shorts and, possibly, to weld opens.

Permanent fixes for ailing picture
(Continued on page 59)

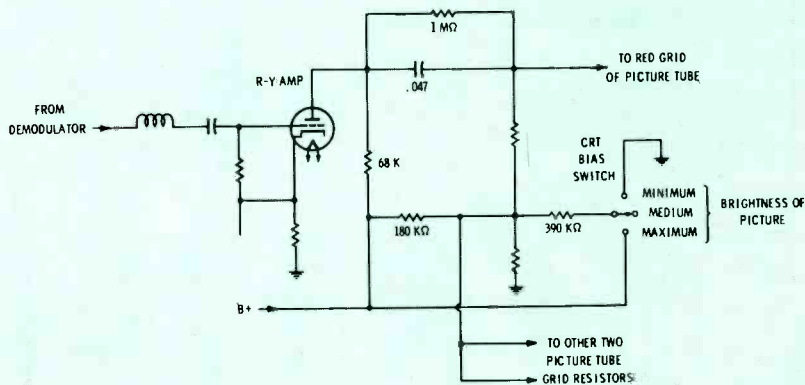
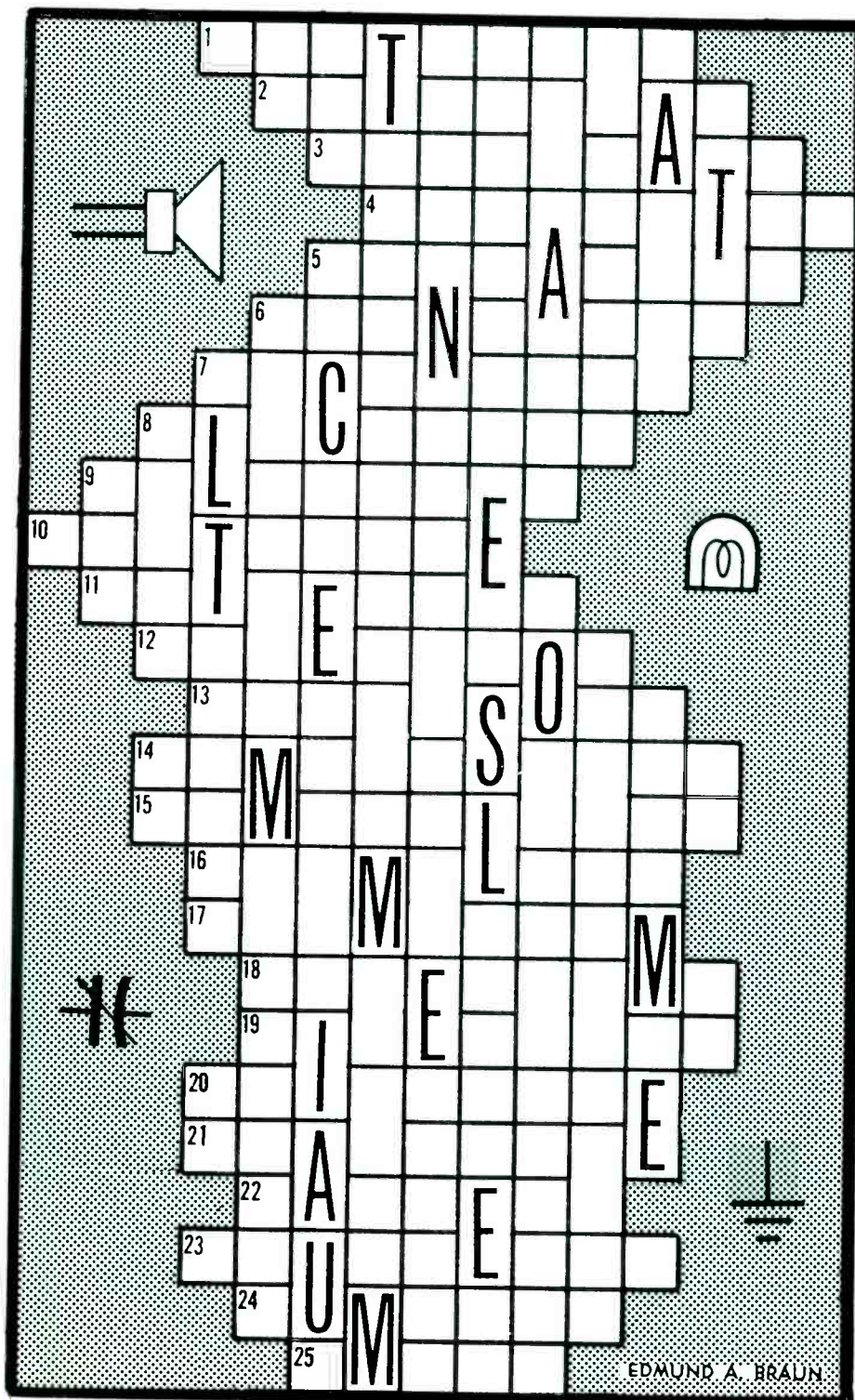

Fig. 5 Older receivers with the color going to the CRT grids and the video to the cathodes can develop dim pictures because of defects in the CRT Bias-Switch circuit. Usually the CRT grids are more positive than the -Y plates, when there is no defect.

CURRENTLY PUZZLED?

By Edmund A. Braun

When you have a few minutes to spare, have fun solving this Just-across-word Puzzle based on electronics. Each word is connected to the word above and below by one or more letters but only one letter is usually shown as a clue. Each correct answer is worth 4 points; a perfect score is 100. It should prove easy to get a high rating except perhaps for someone who thinks "pawl" was Revere's first name, or that "autotransformer" refers to a new paint job on a car! Pencil sharp? Comfortable? Then, GO!



- 1 Electron tube having five grids plus an anode and a cathode.
- 2 Voltage difference between two points of a circuit.
- 3 In microelectronics, the physical material on which circuit is fabricated.
- 4 A condenser.
- 5 Straight line response to an input signal.
- 6 Revolving platform used in recording or playing records.
- 7 Pertaining to the methods and exact details of electronic science.
- 8 Either terminal of an electric source.
- 9 Instrument for measuring EMF.
- 10 Original model from which copies are made.
- 11 Device for producing or storing electricity.
- 12 An addition or prolongation; a type of cord.
- 13 An added or subordinate part.
- 14 Electronic circuit for altering frequency response of an amplifier.
- 15 Pertaining to a carrier transmitted during moments of silence in a program.
- 16 A metal composed mainly of iron and nickel.
- 17 Grayish-white metallic element with many electronic applications.
- 18 A coil with turns wound crisscross to reduce distributed capacitance.
- 19 Picture tube in a television receiver.
- 20 The power unit area radiated by a source of energy.
- 21 A calibrated screen placed in front of a CRT for measuring purposes.
- 22 C.G.S. unit of magnetic flux.
- 23 To produce light when acted upon by radiant energy.
- 24 A drone or buzzing sound.
- 25 The instantaneous illusion of a picture on a flat surface.

Don't peek until you've finished but the solution is on page 47.

EDMUND A. BRAUN

Reports from the test lab

By Carl Babcoke

These monthly reports about electronic test equipment are based on actual examination and operation in the ELECTRONIC SERVICING laboratory. Observations about the performance, and details of new and useful features are spotlighted, along with tips about how to use the instruments for best results.

Two instruments are reviewed this month, a general-purpose scope from Simpson and a small digital multimeter from Data Technology. Let's take the scope first.

General-Purpose Scope

Model 455 general-purpose scope (Figure 1) is offered by the **Simpson Electric Company**. Briefly, these are some of the features:

- AC/DC coupling in both vertical and horizontal amplifiers;
- response of vertical circuit to 10 MHz;
- automatically-calibrated vertical gain steps;
- internal square wave for calibration test;
- facilities for vector displays;



Fig. 1 This is the Simpson Model 455 general-purpose 5-inch scope.

- graticule calibrations for volts and decibels; and
- both tubes and transistors used to obtain the advantages of each type. There are 2 FET's, 22 transistors, 13 diodes and 6 tubes.

Beam controls and circuits

Only four controls are necessary for the electron beam in the CRT: intensity, focus, and two centering controls. They are located along the right edge of the tube.

Voltage regulation of the -20-volt supply minimizes line bounce.

The graticule markings are six centimeter squares high, and ten centimeter squares wide. In addition, radial lines are provided to help you analyze vector displays.

The CRT bezel is of standard size for use with scope cameras, and the graticule can be removed if desired.

Vertical circuits

Nine steps of the volts/CM switch permit scales from 10 millivolt per centimeter to 5 volts per centimeter in a convenient 1, 2, and 5 sequence.

The concentric Variable control

is used to provide waveform heights in between those possible by the switch positions, and also acts as the calibration control, if needed.

At first, it seemed to me the variable control had little range (see Figure 2). But after more knob twiddling, I found the combination of the 1, 2, 5 switch positions and the approximate 2-1/2 to 1 variation of the Variable control was enough to eliminate any gaps and give any desired height of the waveforms. A large variable adjustment is not necessary or desirable when this many positions of the switch are provided.

A banana jack is provided with an internal 1 KHz square wave of .5 volt p-p for gain calibration purposes. In my sample, the gain was correct with the Variable knob turned completely clockwise, a convenient position. If your individual scope requires a different calibration, just touch the probe to the test jack, select the .1 Volts/CM position (if you are using the X1 probe) and adjust the Variable control for a waveform height of 5 squares. It isn't necessary to lock the waveform unless you just want

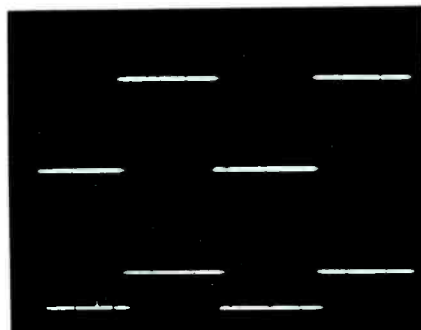

Fig. 2 Top trace shows the amplitude of the internal 1-KHz calibration signal when the Variable control was fully clockwise. The trace at bottom was obtained under the same conditions except the Variable control was CCW.

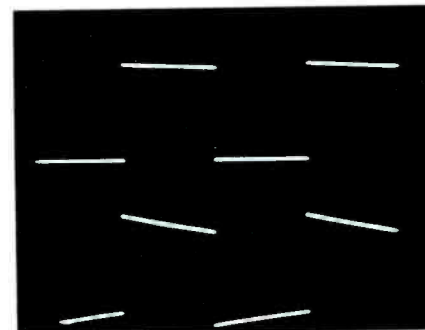

Fig. 3 With the AC/DC switch in the DC position, the 20-Hz square waves had untilted tops and bottoms (trace at top), but the AC position caused slight tilts (bottom trace).

to; without locking, two parallel lines can be seen.

Basically, the vertical amplifier stages are direct coupled. Therefore, the response extends down to DC, except when the AC/DC sliding switch is moved up to the AC position in which a .1 capacitor is connected in series with the input signal. At 60 Hz, there was no tilt, and only a moderate tilt at 20 Hz (Figure 3).

Factory specifications call for a top frequency response of 10 MHz at -3 dB. I have no reason to doubt that rating, because the color burst of a composite waveform had full amplitude.

Corner rounding of the 200-kHz square waves shown in Figure 4 were caused more from limitations of the generator than from any lack of high-frequency response in the scope. Sine waves from 20 Hz to 200 kHz exhibited good low-distortion waveforms (Figure 5).

Completing the lineup of components for the vertical circuit are a BNC-type input socket, and a combination banana plug and screw-type ground terminal.

Simpson catalog number 07548

direct-and-X10 low-capacitance probe is available for \$15. I recommend it for TV work.

Horizontal circuits

Two switches select sweep frequency (recurrent sweep) and the type and source of sync signals. The Sweep Frequency switch has a TV-H position to provide two cycles of any 15,734 Hz signals. The Variable-frequency control also regulates the TV-H function; and that's helpful, because often a slightly-different setting is required (with any scope) because of the exact amplitude or waveshape of the signal.

Frequency of the sweep is adjustable from 1 Hz to 200 KHz in five overlapping ranges.

Width of the trace is adjustable by operation of the smaller knob which is concentric with the Hor Sync/Input switch. In addition, two positions of the switch give X1 or X10 deflection of external signals fed into the Ext Horiz Sync Input post.

Horizontal deflection can be from the internal sawtooth generator, from an internal 60-Hz source with

phase control, or from an external signal.

An AC/DC sliding switch permits full direct coupling or a .1 mfd input coupling capacitor.

Frequency response of the horizontal amplifiers when using an external signal is rated at -3 dB from DC to 500 kHz.

Rear controls

On the back of the instrument is a sliding switch for internal or external connection of the deflection plates of the CRT, Z-axis (intensity modulation) input, ground and two connectors for the deflection plates, and an astigmatic control.

Connecting direct to the deflection plates is useful for viewing RF carriers having frequencies above 10 MHz, and for vector displays. It should not be necessary to adjust the astigmatism control unless the CRT is changed.

Comments on The Model 455 Scope

Operation was straightforward and uncomplicated. Virtually no

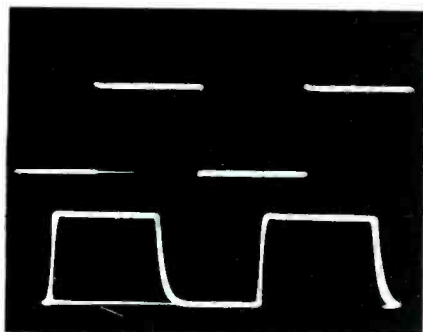

Fig. 4 Comparison of a 1000-Hz square wave (top trace) and one at 200 KHz (bottom trace) shows the scope response was better than that of the generator. Also, notice the scope only showed two cycles at 200 KHz; very good performance for recurrent sweep.

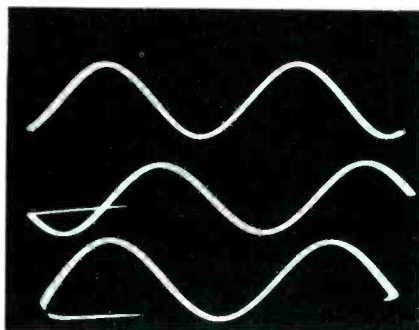

Fig. 5 Sine waves of 20 Hz (top), 1000 Hz (center), and 200 KHz (bottom) are identical in waveshape and amplitude.

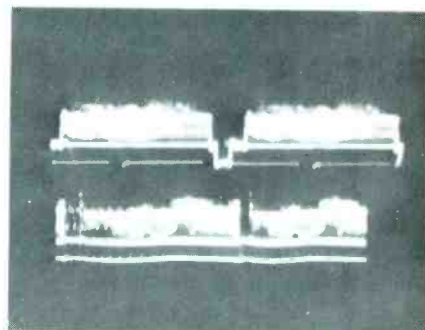

Fig. 6 Composite video viewed at the TV-H sweep had a sharp, steady waveform using internal sync (trace at top). By using a vertical-sweep signal as external sync, the video could be locked solidly at 30 Hz to show two vertical fields (bottom trace).

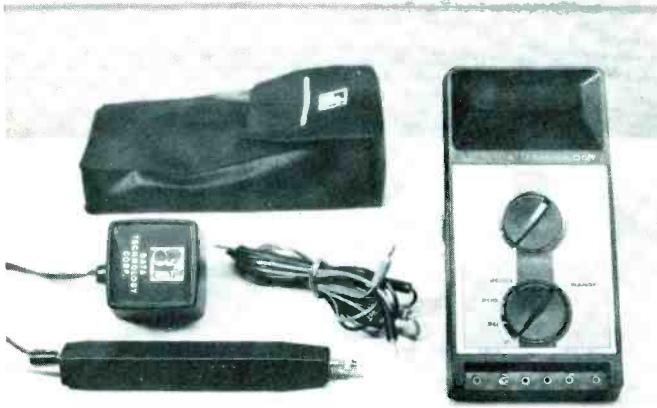

Fig. 7 The Data Technology Model 21 digital volt-ohmmeter is supplied with a carrying case having a hook for hanging from a belt, two test leads and a battery charger. Optional is the press-to-read probe at the lower left.

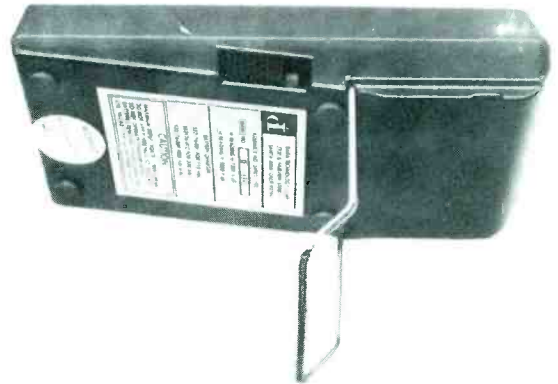

Fig. 8 On the right side of the DMM is a press-to-read switch that can be slid (to the right in the photo) to lock in position if desired. A wire stand can be flipped out to tilt the meter for use on the bench. Of course, the viewing angle doesn't change the accuracy of reading of a digital display.

drift of focus or centering was noticed. Locking on complex waveforms was very good with the exception of video viewed at the vertical rate. There is no internal sync separator circuit. Therefore, you should use external sync from some point of the vertical-deflection system to obtain solid locking at the needed 30 Hz-sweep rate (Figure 6).

Previously, we have described only "gee-whiz" kinds of triggered dual-trace scopes. Apparently the Simpson Company intended the Model 455 to be a good standard general-purpose scope (and it is that). For those of you who might want more scope features, Simpson also offers Model 459, featuring triggered sweep and response up to 15 MHz.

Small DMM

A hand-held digital volt-ohmmeter of extreme accuracy, that also measures capacitance, would be a good, short description of the **Model 21 DMM** from **Data Technology Corporation**.

General description

A soft carrying case with pouch for test leads and a hook for attaching to a belt, an external charger, and two test leads are included with the DMM (Figure 7). Available at extra charge are a press-to-read probe (more about

that later), and a HV probe for readings to 30 KV.

For durability, the case is made of impact-resistance plastic, and the internal components are mounted flat against the board to minimize loosening from vibration.

The 3-1/2-digit .27-inch LED display is recessed behind a dark window to make the readout more visible under poor lighting.

Typically, about 2,000 readings can be taken between chargings of the internal Ni-Cad batteries. The red LED's begin to dim when a charge is needed, but an overnight charge is sufficient.

Figure 8 shows the flip-up stand for use on the bench, and the press-to-read switch on the right side of the case. The switch can be locked in the "on" position by depressing the button and sliding it toward the top of the unit.

Adjustment of the Range switch moves the decimal point to the same position regardless of the function selected. For the 2 Range, the reading with no input is .000, for 20 it reads 0.00, for 200 the reading is 00.0, and for 2000 the readout is 000.

Although the markings of the range switch imply that readings up to 2, 20, 200 and 2.000 can be obtained, this is not quite true. For example, the highest reading possible on the 2-volt DC function is

1.999 volts. This is exactly the same as many other DMM's which list the function as 1 volt with 100% over-range. Disregarding the decimal, any reading which would be above 1999 activates the over-ranging circuit causing the last three digits to flash on and off.

DC volts

On the four DC Voltage ranges, the input resistance is 10 megohms, the readout is directly in volts with automatic minus or plus signs, and accuracy is specified to be $\pm .1\%$ of reading $+ .05\%$ of full scale). Therefore, a reading of nearly 2 volts DC on the 2-volt range would be accurate to $\pm .15\%$ (reading and full scale are the same, so the percentages add). As another example, a reading of .5 volt would have an accuracy of $\pm .30\%$. Of course, all meters (both analog and digital) have reduced accuracy at readings below full scale.

No more than 1.000 volts DC should be applied to the instrument, although the high range implies a top of 1.999 volts.

Although I had no standard meters accurate enough to check the Model 21, the calibration appeared to be perfect. Incidentally, complete re-calibration of all four functions can be done in just a few minutes using five controls, and

without opening the cabinet.

Press-to-read probe

Figure 9 shows an editorial hand operating the press-to-read probe to check a dead 1.5-volt battery. The chuck at the end holds a steel phono needle with either the sharp or blunt end exposed for contacting the circuits. The sharp tip is excellent to prevent the probe from slipping and perhaps causing serious accidental shorts, and also to penetrate solder resist or plastic insulation. I strongly recommend you obtain the probe, if you purchase the meter.

The instrument end of the probe has a rather large plug with four prongs (see Figure 10). And that ties in with the unspoken question about why there should be six jacks at the bottom of the meter. The two at the left are for DC and AC volts, the two at the right are for measuring ohms and capacitance, and the remaining two in the center are for turning on the power when the press-to-read probe is used.

To measure voltages, you insert the plug into the jacks so the markings on the plug read DCV-ACV when you look at it from the side nearest you. Or reverse the plug (Figure 10) so the wires leave at the right side and the plug reads K ohms-nFD, to measure resistances or capacitance.

That's the only trouble I had in using the instrument. Several times I forgot to reverse the plug and

wondered why there was no reading!

The press-to-read feature is great for one-hand operation. Just connect the cold wire to the chassis, touch the probe to the proper point and push the switch for the reading. You can even hold the meter in one hand and the probe in the other for fast and convenient operation.

AC volts

Specifications for the four AC voltage ranges are nearly the same as for the DC ranges. Except that automatic polarity is not needed, and the accuracy is slightly less; $\pm(0.5\%$ of reading $+0.1\%$ of full scale).

There are two precautions. The frequency response is guaranteed only from 50 Hz to 500 Hz at maximum accuracy. In our tests, the readings dropped off rapidly above 3,000 Hz. Therefore, for best accuracy, the AC readings should be restricted to power or to low audio frequencies.

The other thing is that the calibration applies only to sine waves. For example, video waveforms produce readings of perhaps double the correct p-p values.

Testing resistances

All four ranges of the resistance function are direct reading in thousands of ohms (K). For example, a 1,000 ohm resistor would measure 1.000 on the 2 range. Or a 2 ohm

resistor would read .002 on the same scale. Therefore, the top limit is 1,999K or 1.999M.

With infinite resistance (except a test meter) across the test leads, a VTVM measured 17 volts across the probes. The "ground" lead was positive, and the "hot" lead was negative. This voltage dropped rapidly when a resistance was connected. A 2.2K resistor, on the 2K range, activated the over-range indication, and the voltage was -11.3. The same resistor on the 20K range had only -1.15 across it.

Because the ohmmeter current is rigidly limited, there should be no danger to solid-state components that are measured on this meter.

Testing capacitances

This is the only DMM I know of that measures capacitances. The four scales handle readings between 1 pF and 1.999 microfarads.

Again, there's two precautions. First, the display is direct reading, but in nanofarads! That's a term seldom used in servicing. But it's very easy to translate into pF or microfarads. For picofarads, just move the decimal point **three** places to the **right**. Suppose you were measuring a 91 pF capacitor on the 2 range. It would read .091. Move the decimal point three numbers to the right and it becomes 091. For microfarads, move the decimal point **three** places to the left.

Figure 11 shows a .47 capacitor
(Continued on page 59)



Fig. 9 The press-to-read probe with a sharp point is convenient for one-hand operation without the danger that slipping might cause shorts.



Fig. 10 At the meter end of the wires to the press-to-read probe is the large plug which must be turned one direction for volts and reversed for capacitance and resistance readings. The extra two prongs at the center are for the remote switch in the probe.



Fig. 11 Capacitance from 1 pF to 2 microfarads can be measured by Model 21. Readout is in nF, but can be changed easily to pF or uF by shifting the decimal point.

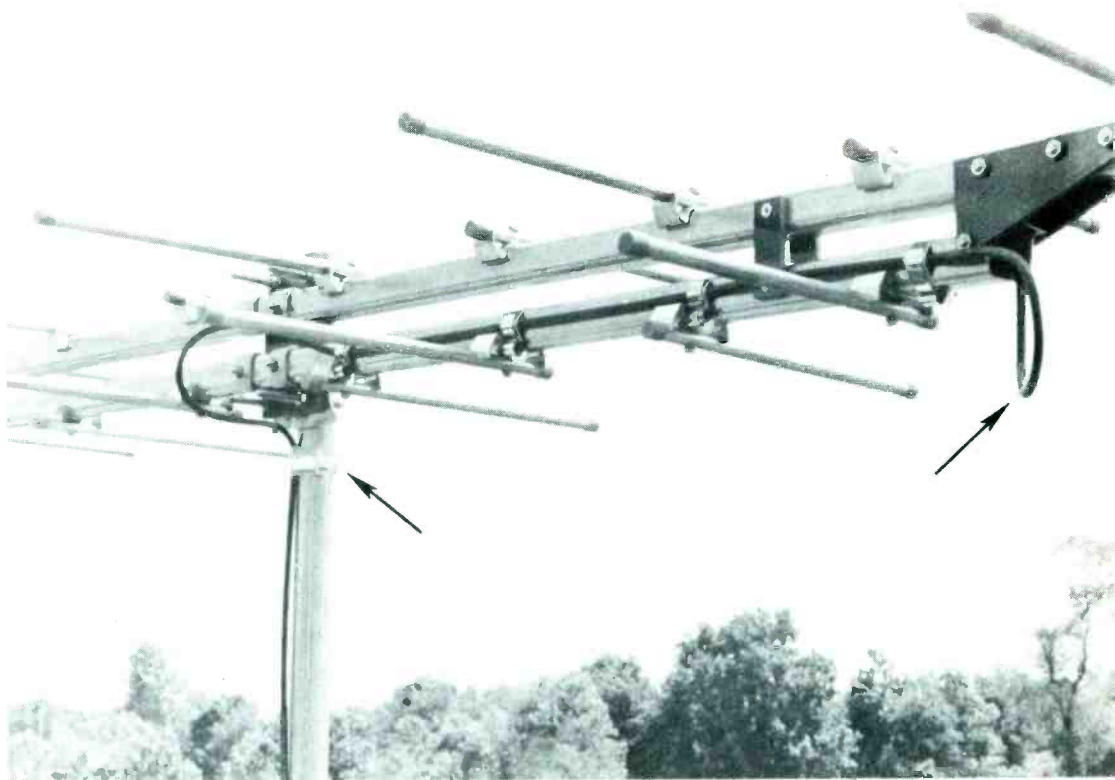

Fig. 1 Add a drip loop at the ends of a horizontal run of cable outdoors (arrow at the right) to prevent moisture from entering. Tape the cable to the mast (arrow at left) and add a strap for strength. Don't crush the cable or make sharp bends.

Professional practices for MATV installations

By Bert Wolf,

General Manager, Jerrold DSD Division

MATV installations come in all sizes, from one antenna feeding two or three TV receivers, to huge systems with several antennas and dozens of tap-offs. But regardless of the size of the job, the suggestions given here will save you time and money.

Any technician who can install a home antenna properly also can install a Master-Antenna TV (MATV) system. However, with MATV it is imperative that the installation be done with more neatness, ruggedness, and durability.

There are several reasons why this is true. Most MATV systems are guaranteed by the installer for the first year, and maintained on a

contract basis thereafter. So, if any slipshod workmanship and faulty components cause excessive maintenance and repairs, the jobs can be costly in the long run.

Also, one of the best ways to sell MATV systems is to show to your prospect another system you have installed. A good system with neat, professional-looking workmanship and excellent signal quality will give you a selling edge that a competitor (who only **talks** a good job) can't overcome.

Mounting The Antenna

Home-type broadband antennas can be used for many MATV systems, and they can be mounted the same as those for use with a single receiver.

However, you should use coaxial cable download, do the job more

painstakingly, and use better-quality materials. Use a heavy-gauge, rustproof 1½-inch mast and stainless-steel hardware. Of course, stainless-steel bolts, nuts, and washers cost more, but for professional jobs they are worth it. If a steel washer rusts, it might not ruin the installation, but it can stain the side of a building, and look ugly. Such attention to small details makes your work more valuable.

Securely tape the coax cable to the boom and mast, leaving drip loops at each end of a horizontal run (Figure 1). Carefully bring the cable into the building by using a weatherhead (Figure 2), or through a hole waterproofed with caulking compound (Figure 3).

As many as two or three separate antennas can be mounted on one mast. In theory, antennas should be

separated vertically by at least 2/3 of a wavelength. But in practice, 1/2 wavelength is sufficient. You don't have to calculate wavelengths, just separate the antennas by a vertical distance equal to the longest element on either antenna. Also, keep the bottom antenna at least 1/2 wavelength from the roof.

Space the antennas away from air conditioners and other facilities. In addition to the degrading effects on the antenna performance, there's the danger the antennas might be damaged during repairs or maintenance

of the air conditioners. Figure 4 shows a typical array of MATV antennas.

Here are some other suggestions:

- Use roofing tar to weatherproof all screw holes in the roof (never use nails);
- Protect the terminals of the antenna with an insulating spray; and
- Solidly ground all masts. Use #8 copper or aluminum wire connecting each mast to a ground rod or cold-water pipe (hot-water pipes, gas pipes and vents are dangerous and should not be used).

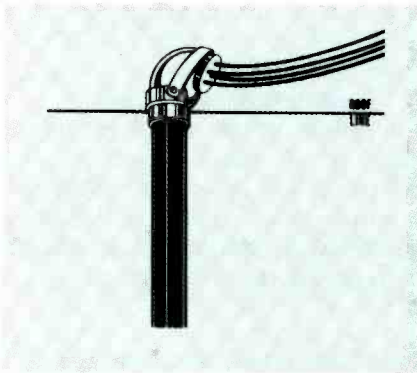

Fig. 2 A weatherhead similar to those for power wiring is an excellent way of bringing the cable through the roof.

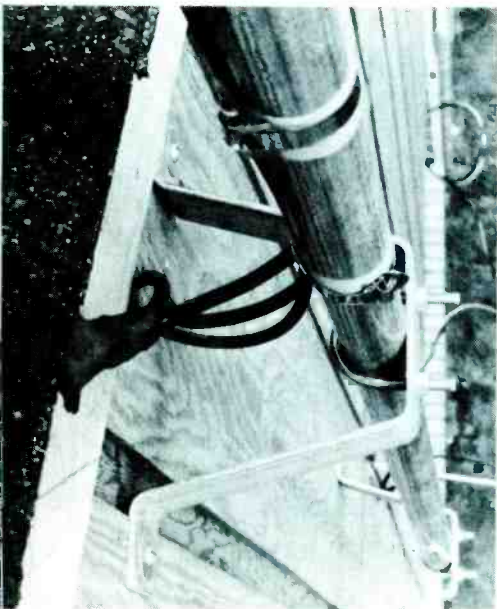

Fig. 3 If cable must be brought through roofing without a weatherhead, waterproof it thoroughly with roofing tar. Or use caulking compound for cables entering through a wall.

Head Ends

Except for preamps (which are mounted on or as close as possible to the antenna), all amplifiers, converters, mixers, splitters and filters should be mounted indoors.

Mount all head-end gear in an equipment housing, such as a cabinet which is well-ventilated and has a removable cover with a lock. Locking is desirable to prevent vandalism and tampering, and the removable feature gives you full access for adjustments, testing, and maintenance.

For large systems using single-channel strips and modulators, mounting on a 19" rack is preferred (see Figure 5). Racks don't have removable covers, so they should be located in a room that can be locked, or is not accessible to unauthorized personnel.

Power

In most MATV systems, the head end is the only part requiring AC power. Unless you're experienced at running AC wiring and can do so under local laws and union rules, engage an electrician to bring power to the head end.

Modern MATV equipment is solid state and draws very little current, perhaps 100 watts for a broadband head end. **But don't make the mistake of plugging into a nearby convenience outlet, or running an extension cord.** There are several reasons for this suggestion. Just one case of hours wasted in checking apartments and power panels looking for the cause of a power loss will convince you.

Another reason deals with safety and responsibility.

Have a separate power line run from the main power panel. This should be a three-wire circuit with its own circuit breaker. Three-wire service is important because it includes the ground wire necessary for UL approval.

Equip the head-end cabinet with a three-wire plug-mold strip having enough outlets for all the powered equipment. Make sure all the active MATV equipment has the UL label, and is equipped with a three-prong plug.

Neat wiring

There is a very important rule about wiring the coaxial cables between the various components of the head end: **Be neat!** Not only does such wiring look better, but it is easier to service and often works better.

Arrange the equipment as neatly and logically as you do the design of the head end. This makes it easier to trace signal flow. Dress the cables carefully and neatly, but allow some slack and **don't make any sharp bends of the coax cable.** Sharp bends can cause the cable to collapse, ruining the impedance match and producing smear and ghosts from standing waves.

Figure 6 shows a head end of attractive appearance. Another system (three pictures of Figure 7) had to be replaced within a year, because of sloppy workmanship.

Running Cables

In any MATV installation, running the cables is a time-consuming job. The type of building construction will determine how you run the cables. If possible, run them during the construction time.

If cable is to be pulled through conduit, chances are the electrical contractor will do the job. However, it is up to you, the MATV subcontractor, to make sure he does it right. The cable should enter the top of each gem box and leave through the bottom, with a 6-inch or 8-inch loop for connection of the tap-off. The loop should be left coiled inside the box. Then, gently tighten the Romex clamp, being

careful not to crush the cable.

If no conduit is to be used, the cables must be supported inside the walls. Use saddle-type clamps, and don't make them too tight. Always beware of crushing the coax.

Coax going through a hole drilled for electrical wires is shown in Figure 8. Although this can save installation time, it can lead to trouble. The electrician might damage the coax while working on the electrical wiring. Don't expect him to know coax should not be bent or crushed. For the same reasons, don't run the coax with telephone wires or plumbing pipes.

Also, don't run the coax in cracks or joists. Such separations might close as the building settles, resulting in damage to the cable.

Wiring in buildings already constructed

In older buildings, cable can be run in several ways. Perhaps the easiest, if the owner doesn't object,

is to run it outdoors, bringing branches in through walls or windows as required.

A good way to run cable inside between floors is through an airshaft. Sometimes it's possible to go vertically through closets for concealed wiring.

When coax can't be concealed indoors, usually it is run along the surface of walls, either with or without wire molding for protection and concealment.

Connecting Tap-Offs

After the sheet rock has been installed, it's time to hook up the tap-offs. Although this is a simple job, it should be done very carefully. A short from stray shield wires can cause hours of trouble-shooting.

Figure 9 shows the installation of a typical tap-off. Start with the last tap-off of each branch line and

work your way back toward the head end. Remove and discard the Romex clamps, and pull the loop of cable out of the gem box. Cut the cable and connect the ends to the two sides of the tap-off. Push the tap-off into the gem box, forcing the excess cable back into the conduit, and tightly secure the tap-off. Don't install the saddle or the cover plate until after the walls are painted. A tap-off in place awaiting the saddle block is shown in Figure 10, while Figure 11 shows an installer putting on a cover plate as the finishing touch. In this case, a double plate was used to match the rest of the plates in the building.

Condominium Systems

Condominiums often involve a number of small buildings, in contrast to apartment houses, motels and other multi-story buildings. Underground wiring is necessary between buildings.

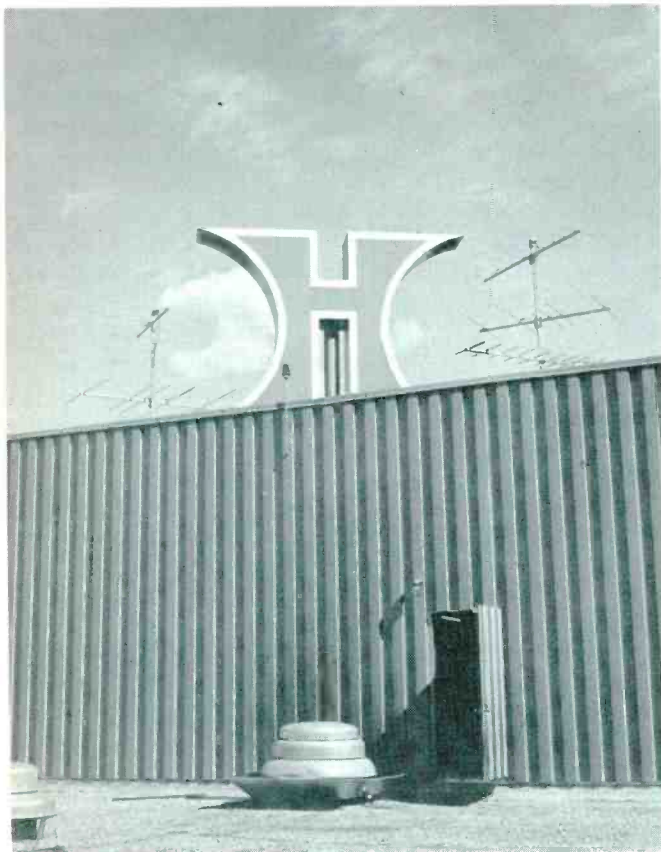

Fig. 4 Large installations often require multiple antennas.

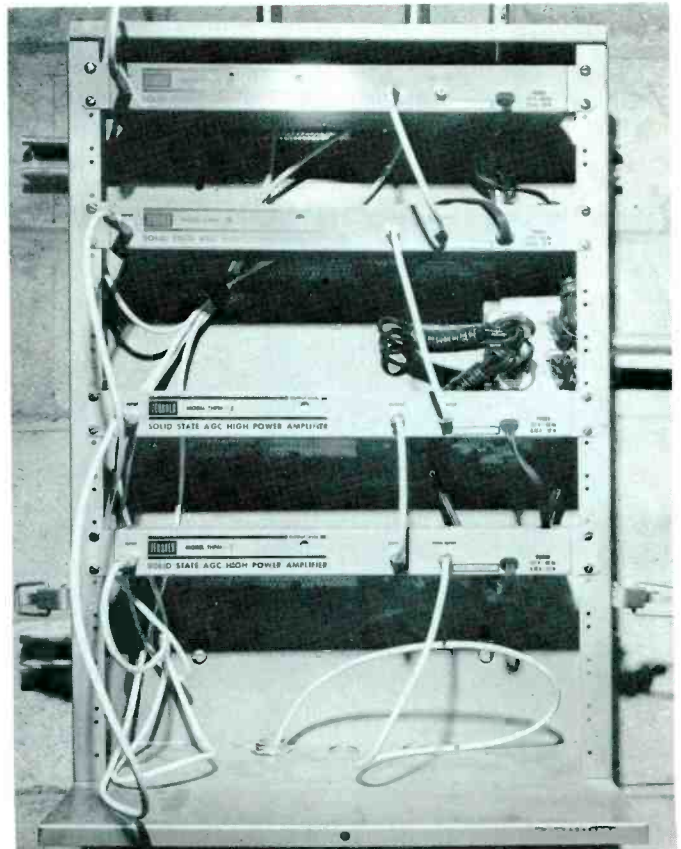

Fig. 5 Mounting in a 19" rack is preferred for single-channel strips and modulators. Notice there are no sharp bends of the cables, and the AC wires have three conductors for safety and UL approval.

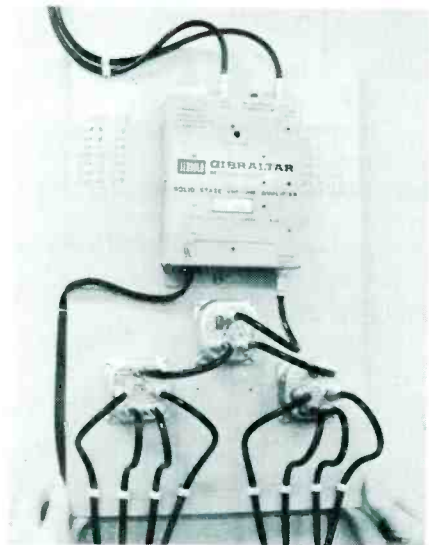

Fig. 6 Example of a neat, attractive broadband MATV head end.

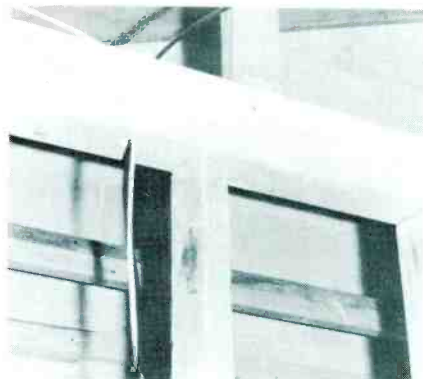

Fig. 8 Running cable through holes already drilled for electrical wires is an easy shortcut. However, damage to the cables from electricians working on the power wiring is always a possibility.

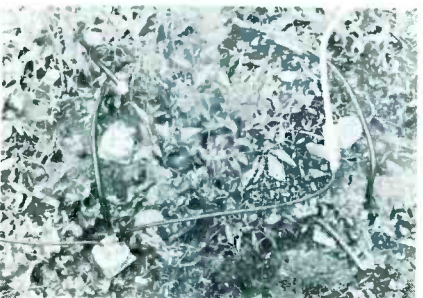
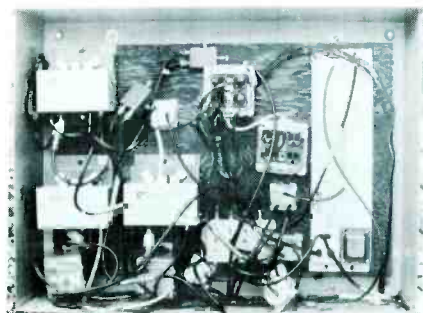

Fig. 7 These pictures show poor workmanship that made necessary replacement of the system after a year because of excessive service.

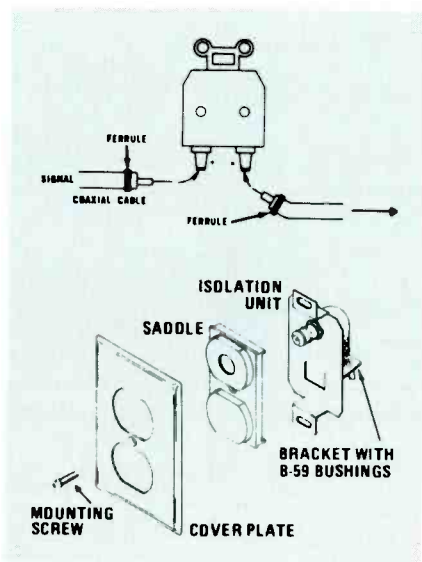

Fig. 9 Details of a typical tap-off.

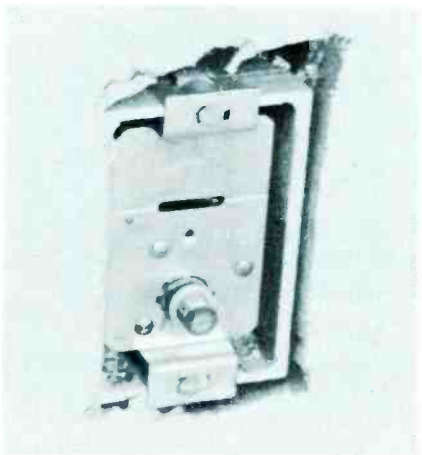

Fig. 10 This tap-off is ready for the saddle block and cover plate.

One example

To make this article as up-to-the-minute as possible, I visited Birchfield, a New Jersey condominium presently under construction. The installation of the MATV is being handled by National Comco, Inc., and Bob Polley, Sales Manager, guided me around the building sites.

Like most MATV salesmen, Mr. Polley is technically trained. He handles layout of the systems, supervises installation and provides follow-up on systems he sells. (Most MATV contractors find that non-technical sales people can't sell MATV systems properly.)

Eventually, Birchfield will use a 60-foot tower to hold an array of yagi antennas and single-channel strips in the head end to pull in both Philadelphia and New York channels. At this point, however, a home-type all-channel antenna is mounted on a roof and connected to a broad-band amplifier to provide signals temporarily to the few finished units.

Cable is run from building to building in trenches (see Figure 12). After the cable is buried, the trenches are back filled and the grass is replaced. Beside each building, the cable is stubbed as shown in Figure 13. Notice that the end of the cable is taped carefully. National Comco uses aluminum-sheathed cable with flooding compound, which is made specifically for earth burial. However, even with this type of cable, unprotected ends might admit water, causing severe losses of signal.

Jerrold amplifiers and splitters are housed in pedestals (Figure 14) outside each condominium. If needed, holes can be made easily in the pedestals, using a pneumatic hole punch (Figure 15).

In the attic of each building, four-output multi-taps are used (Figure 16). From there, lines are run through the walls and terminated at plaster rings.

Checking Out The System

After the system is installed, it must be turned on, balanced for

signals, and checked out. For these steps, you definitely need a field-strength meter (Figure 17) and a portable TV receiver, preferably color.

Start at the head end. Check signals into and out of every piece of active equipment, making sure the levels are within the limits specified by the manufacturer.

If you're using broadband amplifiers, do the best you can to balance input signal levels. There should be no more than 6 dB difference between the strongest and weakest

channels (3 dB is the maximum for two adjacent channels). Use pre-amps, filters, traps and attenuators to achieve this balance.

Then with the gain controls, set the output levels of the amplifiers to the ones calculated when the system was designed, using the field-strength meter to guide you.

Of course, strip (single-channel) amplifiers are easier to balance than broadband ones, because each channel individually can be controlled. Seldom are adjustments of the input signals necessary. How-

ever, if adjacent channels are received, check the level of the sound carrier of the lower channel. It should be 12 to 18 dB below the level of the upper-channel picture carrier. If the level is too high, use a sound trap to reduce it.

If the strip amplifiers have AGC, be sure to check the adjustment according to the manufacturer's specifications. Don't neglect this step, because high-Q AGC circuits easily can become misaligned in shipping.

After you obtain the right read-



Fig. 11 The installer is finishing a tap-off after the wall has been painted.

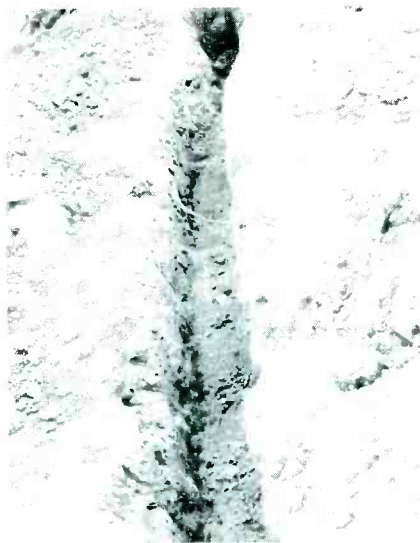

Fig. 12 Coax cables between buildings should be run in moderately-deep trenches.

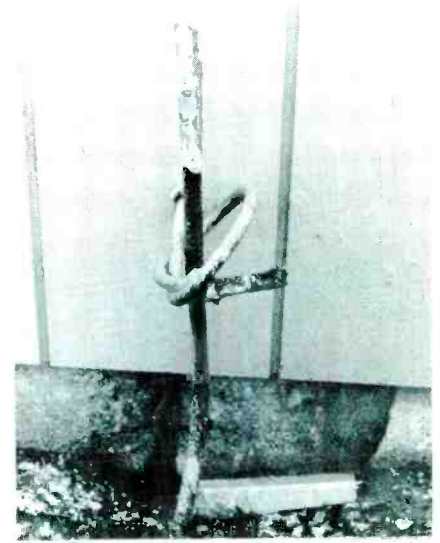

Fig. 13 Indoor and outdoor cables are shown ready for the weatherproof pedestal. Notice the end of the underground cable has been taped to keep out moisture.



Fig. 14 Metal, weatherproof pedestals outside each building house and protect splitters and amplifiers.

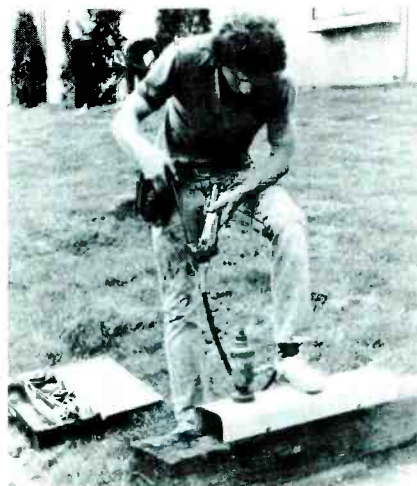

Fig. 15 Holes in the pedestal easily and rapidly can be made with a pneumatic punch.

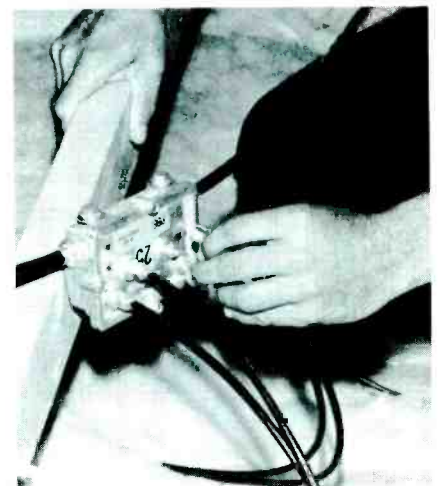

Fig. 16 Four-output multi-taps are installed in the attic.

ings on all sound and picture carriers out of the head end, use an attenuator to simulate losses of the distribution system and check each channel with the TV receiver (color preferred) for ghosts, smears, and interference.

Make a record

After you have the head end set up the way you want it, record all input and output operating levels on the print of the system layout. If you have added any filters or traps, record them on the print. Also, record the tuning of all traps.

Bring this marked-up print back to the office and have an "as built" drawing of the system made. Keep one of the drawings and give one to the owner of the system. These drawings are not only very valuable for servicing, but they can be of immense help to you in designing new systems for the same general area.

Checking feeder lines

Test every feeder line in three ways: with an ohmmeter, with a field-strength meter, and with a TV set.

At the head end, disconnect the line from the splitter and measure the resistance between the shield and the center conductor. You should read about 100 ohms, about 75 ohms from the termination resistor plus the DC resistance of the cable. If the line reads open, one of the taps is wired wrong, or there is no terminating resistor at the end of the line. If the line reads a short, you will have to check each tap-off and connector to find it.

However, remember that some types of splitters, directional couplers and tap-offs provide a DC path to ground. You should know which ones are of this kind before you waste time in useless testing.

Next, check the tap-offs for signal strength and picture quality. Figure 17 shows Bob Polley checking signal level at one of the Birchfield tap-offs. Ideally, you should check every tap-off on every line, but this is seldom practical. Usually, it's sufficient to check the first tap-off to be sure the signal level isn't excessive (might cause receiver overload), and the last tap-off for sufficient signal (too little produces snow in the picture).

After the tests with the field-strength meter, connect a color TV to at least one tap-off in each line. This is the only way to detect problems such as direct pickup which could not be seen at the head end.

Eliminating Direct Pickup

Direct pickup is a problem that is peculiar to systems with one or more strong local stations. Elimination often is difficult, and it's advisable that you consider the problem during the design of the system.

Direct pickup occurs on the twin lead between the matching transformer and the TV receiver, or by the tuner wiring of the set. The desired signal through the MATV system is delayed slightly, so images from the direct pickup appear to the left of the main picture. Ghosts picked up by the MATV antennas are located to the right of the picture, in the conventional way.

All tap-offs should be 75-ohm types, the matching transformers at the receivers should have excellent balance, and the twin-lead from the transformer to antenna terminals on the receiver should be as short

as possible. A few modern receivers have a shielded 75-ohm input, which of course should be used without the matching transformer.

One standard cure is to design the system to provide more than the customary 0 dB (1000 microvolts) at each tap-off. Solid-state tuners in receivers overload more easily than the tube counterparts; however, most solid-state receivers (after a careful adjustment of the AGC controls) can tolerate signals up to perhaps 3000 microvolts. To be on the safe side, provide levels of about 2000 microvolts (+6 dB).

If all other methods fail, there are converters that not only help eliminate the direct pickup (by having complete shielding), but also provide remote channel selection and fine tuning.

Summary

Good-quality equipment installed carefully by good workmanship should result in a system that delivers excellent picture quality. A few extra minutes spent in avoiding shorts and damage to the cable will prevent hours of troubleshooting. □



Fig. 17 Bob Polley, Sales Manager for National Comco, is pictured checking the video and audio carrier levels of each channel at one tap-off.

Profitable intermittents

By John S. Hanson, CET

Do you believe repairs on intermittents always cause financial losses because the times exceed the flat-rate charges? Many technicians do. Unfortunately, such beliefs are likely to produce defeatist attitudes which can hinder efficient servicing.

Instead of dreading intermittents as difficult problems, look on them as challenges. Ask yourself: what techniques or equipment should I use to make the intermittent condition start or stop when I want it to? Two general methods, often neglected, involve controlled temperature and variable voltage.

Changing The Temperature

Traditionally, technicians warmed cranky chassis by placing boxes or quilts over them. This method has many disadvantages. The entire chassis and all parts become hot at nearly the same rate, not permitting any pinpointing. Also, it is easy to overheat and pass the point of best action.

Heating can be done more rapidly and more selectively by using a hair dryer fitted with a funnel to focus the heat, and a switch permitting air flow without the heat.

A can of pressurized coolant with a narrow outlet tube is an ideal tool for cooling individual parts.

Use these devices for alternate

heating and cooling, and you'll wonder why you waited so long to try them.

Variable Line Voltage

Some defects show up more often when the line voltage is low, others respond faster to abnormally-high line voltage. A gadget is needed to supply the exact voltage you want. In addition, much data can be obtained by measuring the current drawn from the power line.

The components of Figure 1 fill the bill. They can be assembled in many different ways. The one I like best is to fasten a small metal chassis to the rear of a variable transformer, and mount the two meters and the outlet on the chassis. The gadget is easily moved from bench to bench, or can be taken on service calls.

A few TV receivers have regulations that offset any attempt to change the supply voltages. Some Zeniths have a saturable power transformer whose output is a square wave that does not vary much with different line voltages. Also, some versions of the new Quasar regulate the B+ supply by varying the conduction time of the power supply rectifiers. Even with those sets, who's to say that a different line voltage wouldn't trigger an intermittent in the **regulation** circuit?

One Example

A popular circuit that lends itself quite well to the variable-voltage

technique is RCA's XL-100 solid-state chassis. A study of the circuit reveals no regulation of the basic power supply. Therefore, power supply voltages can be shifted by varying the line voltage.

In the XL-100, voltage regulation occurs within the circuit modules, insuring good isolation, and preventing catastrophic failures because of power supply defects.

Shifting the line voltage will directly affect the horizontal sweep, vertical sweep, high voltage, audio, and picture tube drive circuits. This provides many troubleshooting possibilities.

One common problem is intermittent circuit-breaker tripping. Many technicians replace the power-supply module, and even the breaker, then leave with fingers crossed. A more conclusive way is to vary the line voltage and watch the current meter. If the current rises just before the breaker pops, something in the circuit is drawing excessive current, and should be repaired. On the other hand, if the current did not increase as the breaker tripped, the breaker is defective and should be replaced.

Finding transient shorts

Many hard-to-find shorts are what I call "pulse shorts." These are breakdowns that occur during the peak amplitude of the pulses. Therefore, they can't be measured by the usual DC methods. The horizontal pulse shorts might be caused by cracks in the mica insulator of a SCR, an internal arc in the input reactor, or a breakdown (arc) inside the commutating or efficiency capacitors.

The technique for finding such intermittents starts with determining which line voltage causes the problem most often. Then the various auxiliary circuits are disconnected to see which one eliminates the symptom. Removing the loads of these circuits tends to increase the amplitude of the pulses, so the line voltage should be reduced to

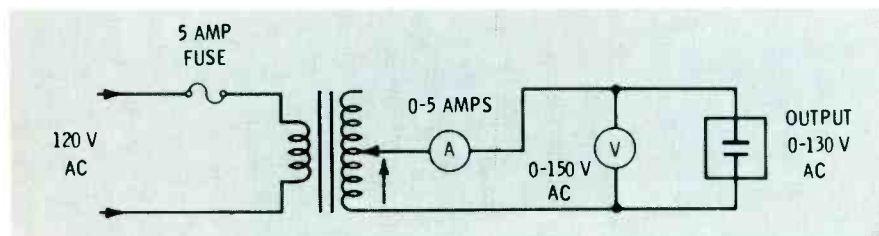

Fig. 1. We recommend you build this circuit for adjusting and measuring line voltage. Use a variable isolation transformer, as shown, and you won't have to worry about the dangers of working on "hot" chassis sets.

compensate for the change.

Signal Variations

The nastiest intermittent is one that acts up often for the customer, yet it works normally for hours when operated in the shop.

Think about the contrast of conditions. Probably the chassis is standing open on the bench, with a different line voltage, and a whole new set of signal amplitudes. We've already discussed temperature and voltage variations.

I suggest you use your color bar generator to supply the signals instead of the usual stations. Add an adjustable loss pad so the signal level can be varied over a wide range. In addition to showing snow and overload conditions, certain types of intermittents can be triggered by the right signal level.

Summary

If you practice using these techniques of varying the temperature, line voltage and signal strength, I'm sure you will be able to finish most intermittents the first time across the bench, rather than resorting to cooking them interminably. □

(Continued from page 33)

Solution to: CURRENTLY PUZZLED?

- | | |
|--------------|----------------|
| 1 pentagrid | 13 accessory |
| 2 potential | 14 compensator |
| 3 substrate | 15 unmodulated |
| 4 capacitor | 16 permalloy |
| 5 linearity | 17 germanium |
| 6 turntable | 18 honeycomb |
| 7 technical | 19 kinescope |
| 8 electrode | 20 emittance |
| 9 voltmeter | 21 graticule |
| 10 prototype | 22 maxwell |
| 11 batteries | 23 fluoresce |
| 12 extension | 24 humming |
| 25 image | |

Start with 100 points and deduct 4 points for any part you may not have answered correctly.

Your rating:

- 60 - 64 Fair but not good.
- 68 - 72 Good but not very good.
- 76 - 84 Very good but not excellent.
- 88 - 96 Excellent but not perfect.
- 100 PERFECT! Watt a score!

DUST

STICKS TO OIL, SILICONE, GREASE.

Dust sticks to every protective lubricant used in every tuner cleaner/lubricant on the market today - including our **BLUE STUFF**, **KLEEN-IT** and **COLOR RID OX**.

*We thought it would be a real help if we could make one that refused to collect dust. **

HASSLE

IS WHAT YOU NEED LESS OF

Up until now, either you had to be super careful where you sprayed the tuner cleaner/lubricant you used or it went all over everything and soon collected dust and contamination. If you wanted to do the best job — you pulled the tuner, — so you could keep the lubricant away from sensitive areas.

We thought it would be a help to design a tuner cleaner/lubricant just for house calls, one that would make your tuner cleaning on house calls easier, safer and more thorough, one where you wouldn't have to pull the tuner to do the best job.

**We've
Done Both
And It's
Called**

* Test it yourself, take your present tuner cleaner/lubricant, spray a spot on a smooth surface next to a spot of **TUNER CARE**, let them both dry and sprinkle cigarette ashes over both spots. Then wipe gently. The ashes will stick to your present tuner cleaner/lubricant and won't stick to the **TUNER CARE**.

**AT YOUR
FAVORITE
DISTRIBUTORS**



from **TECH SPRAY** where we find solutions for your problems

SPRAY AWAY THE RACKET.



Squeak. Whine. Whirr. Pss! Silence. Quietrol did it again. Silenced those moving T.V. parts, with one squirt from the handy spray pack. Cleaned away dirt, dust, and crud. Without damaging anything... in any black and white or color set. Silence is golden. So is Quietrol.

Also available in bottles, and the new Silicone—"Silitron."



Product of
QUIETROLE
COMPANY
Spartanburg, South Carolina

For More Details Circle (14) on Reply Card

Transistor Repairs

(Continued from page 26)

I traced the two power sockets on the top side of the power amplifier chassis. Only one pin went to a chassis ground, and it doubled as the shielding of the audio-input wire that went to C1. (There's C1 again.) What's more, there was no matching wire in the male plug coming from the generators and volume control circuitry.

But suspended in the air beside the cables above the plugs was a bare connection, two wires soldered together, and no tape or insulation. Both wires went to different "ground" lugs on the generator boards. **Such wiring couldn't be right!**

While having mixed feelings of apprehension and hope, I soldered the two wires to the blank pin of the 5-prong male plug. **Afterwards, the hum was gone, and the organ played when the notes were depressed.**

Postlude

(musical term for last number)

Before I soldered them to the

pin, I noticed the wires were soldered to each other, but never had been soldered to the pin of the plug. No tinning was on the pin. Evidently, when I turned the chassis so I could reach the components on the inside, the wires pulled out of the plug, leaving the generator circuits floating without a ground.

However, the B+ circuits were intact, so about +50 volts appeared at the negative side of the input capacitor, C1. (Normally, this point is zero volts.) Such high voltage reverse biased the capacitor, causing excessive leakage which supplied too much forward bias to Q1. Therefore, the capacitor leakage caused both Q1 and Q2 to be biased into saturation and no gain.

Without a ground path to the power supply, the generators could not conduct, so the organ would have been dead even without the loss of gain in Q1 and Q2. Without the generator current, the B+ was increased at the filter capacitors, making them run hot.

Everything was explained except the hum heard when the ground was open. One thought was that it might have been caused by electrostatic hum from the ungrounded chassis being amplified by the transistors. But that's impossible, because the hum was there with Q1 and Q2 biased into saturation (which gives nearly zero gain), with them removed from the circuit, and with the primary of T1 shorted with a jumper wire.

The only explanation making any sense is that an active filter was included on the generator chassis. Such filters operate by amplifying hum and signal ripple, inverting the phase and feeding the correction signal back into the B+. In other words, the hum is phased out, not removed by a low-pass filter action.

All in all, the twin defects led me a merry chase. And the fact that I found the troubles by using basic electronic knowledge and practical troubleshooting techniques proves that it's possible to service without schematics. **But it's certainly servicing the hard way!** □

TeleMatic

MJ-195

MASTER TEST RIG FOR TUBE AND SOLID STATE SERVICING



\$149.95

less 19" picture tube

- 30 KV CAPACITY
- METAL CABINET
- SPEAKER BUILT IN
- HIGH VOLTAGE METER
- STATIC CONVERGENCE
- FRONT PANEL CONNECTIONS

TeleMatic

2245 Pitkin Ave., Brooklyn, N.Y. 11207

FREE! Adaptor Quick Reference Chart

For More Details Circle (28) on Reply Card

Keep America Beautiful

advertising contributed for the public good

People start pollution.
People can stop it.

test equipment report

These features supplied by the manufacturers are listed at no-charge to them as a service to our readers

If you want factory bulletins, circle the corresponding number on the Reply Card and mail it to us.

Resistance Test Unit



Small enough to be easily hand-held, a new aluminum-housed resistance substitution unit by **Phipps and Bird, Inc.** features an 11-million-step range in 1-ohm steps. Suitable for circuit design, instrument repair, and troubleshooting, Model 236-A uses 1/2-watt resistors with 1% accuracy tolerance. Designed with three binding posts (one to ground case), the slide switch unit provides a range from 1 to 11,111,110 ohms.

Model 236-A measures 4 X 6 X 1-3/16 inches and sells for \$48.00.

For More Details Circle (35) on Reply Card

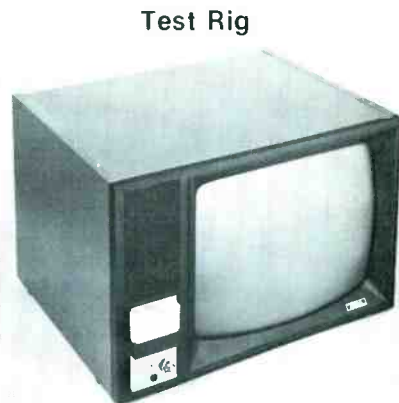

Test Rig

The Master Rig Model MJ-195 is a complete set-up for both tube and solid-state chassis. Features include a built-in high voltage meter, speaker, front panel connections and metal cabinet. When equipped with the proper CRT, Model MJ-195 is capable of operating with late-model chassis delivering over 30 KV.

Available from **Telematic**, the Master Rig comes complete with all components for the deflection circuit hook-up and 4 solid-state yoke adapters; it sells for \$149.95 without a picture tube.

For More Details Circle (37) on Reply Card

(Continued on page 50)

Digital Multimeter

United Systems Corporation has announced the availability of Model 2180 digital multimeter, a 3-1/2 digit, bi-polar instrument with all five standard multimeter functions, plus five decibel measurement ranges extending from -60 dB to +56 dB. Features include a basic accuracy of 0.1%, resolution of 100 uV, and operation from either the AC line or internal rechargeable batteries.



The functions of the multimeter are pushbutton selected and include AC volts, DC volts, AC current, DC current, resistance and decibels. Its 31 measuring ranges are selected by rotary switch with an additional battery check position. All circuit boards, IC's and displays are plug-in for easy maintenance.

Model 2180 digital multimeter sells for \$395.00.

For More Details Circle (36) on Reply Card

BOTTOMS UP



Start saving the gray bottom flaps with the GE monogram from GE entertainment receiving tube cartons. They're worth valuable awards to independent service dealers and technicians in a fabulous gift bonanza program from General Electric.

The gift list includes some 43 items ranging from sporting equipment to home appliances, from diamond jewelry

to distinctive luggage, from globes and books to calculators and Attend-a-Phones. It even includes the much prized Polaroid SX-70 camera and American Experience weekend vacations at any one of 101 prestigious resorts.

BOTTOMS UP!!! Redeem your flaps by November 30, 1974. Full details at your authorized distributor.

TUBE PRODUCTS DEPARTMENT
GENERAL ELECTRIC COMPANY
OWENSBORO, KENTUCKY 42301

GENERAL  ELECTRIC

FREE EICO CATALOG

346 Ways To Save On Instruments!

EICO's Test Instruments line is the industry's most comprehensive because each instrument serves a specific group of professional needs. You name the requirement—from a resistance box to a VTVM, from a signal tracer to a scope, from a tube tester to a color TV generator, etc., you can depend on EICO to give you the best professional value. Compare our latest solid state instruments at your local EICO Electronics Distributor, he knows your needs best—and serves your requirements with the best values!

"Build-it-Yourself" and save up to 50% with our famous electronic kits.

For latest EICO Catalog on Test Instruments, Automotive and Hobby Electronics, Eicocraft Project kits, Burglar-Fire Alarm Systems and name of nearest EICO Distributor, check reader service card or send 50¢ for fast first class mail service.

**EICO—283 Malta Street,
Brooklyn, N.Y. 11207**

30 years of service to the Professional Serviceman.



For More Details Circle (13) on Reply Card

test equipment report

(Continued from previous page)

3-Way Receptacle Tester

Check-U-Ground by **Communications Technology Corporation** is designed for testing 3-way grounding AC receptacles to assure their maximum safety and optimum working conditions. The simple, two-step testing mode provides both visible and audible readouts, and checks for absence of line voltage, open ground lead, open neutral lead, reversed polarity (hot and neutral), hot ground (reversed hot and ground leads) and verifies the presence of low effective resistance of the receptacle ground by placing a heavy test current over the grounding conductor.

The instrument is compact, handheld and requires no batteries; power is obtained from the receptacle being tested, which makes the unit independent and completely portable. The readout display has 3 lights and a buzzer alarm.

For More Details Circle (38) on Reply Card

Marine Wattmeter Trouble Alert

The GLC 1078A marine-radio trouble alert shows if a radio and antenna system is transmitting. A green on-the-air light indicates proper functioning of the antenna system. If a short or open develops in the line, a red-light alert comes on. A meter indicates wasted power and by tuning a control knob, power loss can be minimized.

Available from **Gold Line**, the GLC 1078A sells for \$39.95.

For More Details Circle (39) on Reply Card

Triggered Scope

Sencore, Inc. has introduced an automatic, triggered, pushbutton oscilloscope, the PS29 Minute Man. The scope enables the technician to display any color TV or video waveform by simply pushing a button. Pushbutton displays include TV vertical, TV horizontal, 3.58 MHz, for viewing the color subcarrier information, five times expand, and a completely front-end vector display. The sixth button sets the scope for 60-Hz line sweep.

The Minute Man triggers internally on any signal down to 20 millivolts. External trigger allows the technician to sync on any signal above a DC voltage. Absence of input signal is indicated by a continuous running baseline.

RF Adapter



Hewlett-Packard is offering Model 97003A RF adapter which adds a 100 KHz to 500 MHz AC-measurement range to their Model 970A digital multimeter. Accuracy within this frequency range is greater than 1 dB. The probe can measure voltages from 0.25 to 30 volts full scale. Maximum AC input is 30 volts RMS plus 200 volts DC. Input resistance is greater than 25,000 ohms, shunted by less than 4pF.

Model 97003A RF adapter sells for \$85.00.

For More Details Circle (40) on Reply Card

Digital VOM

Model 460-2 digital VOM from **Simpson Electric Company** offers the advantages of both digital and analog displays in a portable, laboratory-quality instrument.

The 460-2 operates either from AC line voltage or automatically-recharging internal batteries. Primary readout is a 0.33-inch high, non-blinking 3-1/2 digit LED display with automatic blanking of non-significant zeros. Analog readout is a dual-scale rotating drum meter that complements the digital display by making it easy to scan peaks or nulls on its linear lower scale.

The 460-2 digital VOM sells for \$375.00.

For More Details Circle (41) on Reply Card

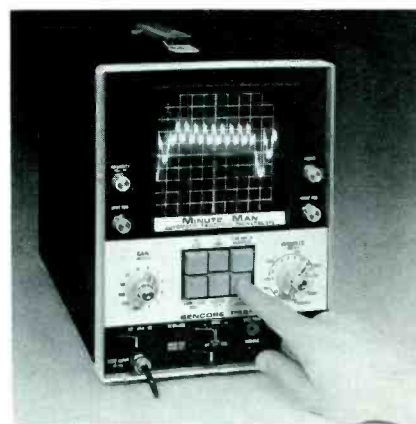

The PS29 sells for \$495.00, probe included.

For More Details Circle (42) on Reply Card

productreport

These features supplied by the manufacturers are listed at no-charge to them as a service to our readers. If you want factory bulletins, circle the corresponding number on the Reply Card and mail it to us.

Remote Control Unit

A new type of remote control unit that works with any TV set is offered by **Jerrold Electronics**. Completely solid state and without motors, Model TRC-12 turns a TV set on and off, changes channels instantly, and fine tunes from anywhere in the room, up to 25 feet from the set. The TRC-12 consists of two units, a converter and a remote control, connected by a 25-foot control cord.

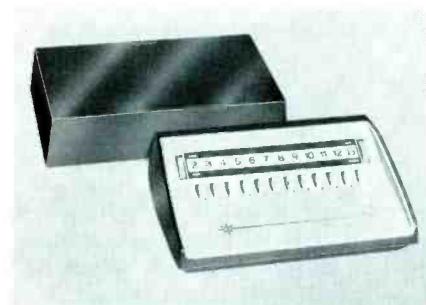

The converter can be located any convenient distance from the TV set; it is permanently installed and may be concealed. The only wiring necessary is attaching the TV antenna lead-in to the converter, and then attaching the converter output to the antenna terminals on the back of the TV set. There is no need to remove the back of the set and no special tools are required.

Model TRC-12 universal TV remote control sells for \$100.00.

For More Details Circle (43) on Reply Card

Intrusion Alarm

Model CA3 ultrasonic intrusion alarm from **Mallory Distributor Products Company** is both an area and perimeter protection device. Built-in features include special circuitry to guard against false alarms from line transients and insects, and the capability of using a variety of accessories for virtually any security needed.

The versatility of the CA3, which operates on 120 VAC and has a loud built-in horn, comes from the options available through the use of controls on the back of the case. These controls include a 120 VAC, 3-amp outlet energized when detection occurs, a three-position selector switch to select immediate alarm or entrance-delay alarm, an on-off horn switch for local or silent alarm, remote-reset con-

nections, switch-loop connections for perimeter protection (both open or closed), and a response control that can be adjusted for the length of time movement must occur before detection. These controls allow the CA3 installer to customize the intrusion warning he desires.

For More Details Circle (44) on Reply Card

Replacement Parts

The Electronic Components Group of **GTE Sylvania** has added a series of integrated circuits and solid-state modules, intended as direct replacements for their imported counterparts, to its ECG semi-conductor product line.

The ECG 1000 series consists of silicon monolithic integrated circuits and both thick- and thin-film hybrid encapsulated modules.

For More Details Circle (45) on Reply Card

Pocket-Sized Calculator

The HP-70 pocket-sized business calculator by **Hewlett-Packard** is programmed for the four basic arithmetic functions as well as 21 of the most common equations used in business and personal finance. Other features include a four-memory operational stack as well as two independent memories for intermediate storage of numbers, and a 10-digit display that is accurate to within a penny in a \$1 million transaction.



The HP-70 calculator sells for \$275.00.

For More Details Circle (46) on Reply Card

Heavy-Duty Ladders

A new line of heavy-duty aluminum ladders developed to meet the needs of professionals whose ladders get rough and frequent use is available from **Perma Power**. The line includes both straight ladders and extension ladders, in all popular sizes from 12 feet through 40 feet.

Designed for outdoor as well as indoor use, the ladders are designated

SUPER SPECIALS

CONDENSERS CANS	
300 Mfd. 200 Volts	4 for \$2.19
400 Mfd. 200 Volts	4 for \$2.39
500 Mfd. 50 Volts	3 for \$2.19
200 Mfd-80 Mfd.-350 Volts	3 for \$1.79
250 Mfd.-40 Volts	5 for \$1.00
25 Assorted Filters	\$4.95

ANTENNA EQUIPMENT	
6-Ant. Clothespins	\$1.19
RMS-2 Set Coupler	\$1.89
RMS-4 Set Coupler	\$2.79
6-Coaxial "F" Connectors	\$1.19

SPEAKERS	
6X9	\$2.99
8" Round	\$2.29
6" Round	\$1.79
4" Square	\$1.89

CONTROLS-RESISTORS	
50 Asst'd Controls	\$2.98
50 Asst'd W. W. Res	\$2.69
100 Asst'd Carbon Resistors	\$1.69
1 Meg. V.C./Sw—P.P.	3 for \$1.19
66 Meg. HV res.	4 for \$2.00
70% Conv. Assembly	\$1.00
CRT BOOSTER 70%	\$4.29 (COLOR)
CRT BOOSTER 90%	\$4.59 (COLOR)
10 HV Anode Leads	\$1.00
25 Asst'd Plate Caps	\$1.00
Audio Output Xfmrs	2 for \$1.00
DELAY LINES	2 for \$1.19
25 Terminal Strips	\$1.00
Shunt Reg. Hoods	2 for \$1.00
10 Asst'd Align. Tools	\$1.98
TUNER CLEANER-8oz. Spray	\$1.00
50 Asst'd I/Fxfrms	\$2.49
20 Asst'd Tube Sockets	\$1.00

COLOR FLYBACKS	
RCA 136640	\$7.95
RCA 137545	\$7.95
EMERSON 738229A	\$3.95
PHILCO	32-10132-1 \$3.95

DIODES—SEMI-CONDUCTORS	
25 IR 2.5 A-1000 PIV	\$4.95
100 IR 2.5 A-1000 PIV	\$14.95
6500 PIV Focus Rect.	4 for \$2.00
13.5 KV Focus Rect.	5 for \$3.00
3.58 Mhz. Crystals	3 for \$2.00
25—1N34A Crystal Diodes	\$2.00
5—Boost Rectifiers	\$2.00

COLOR YOKES	
EQUIV. DY 95AC-Y109 (Univ)	\$6.95
JAP COLOR YOKE	\$4.95
Y-133—Adm.—Mag.	\$3.95
SILVERTONE 80-56-4G	\$5.95
70% (21" CRT ROUND)	\$8.95

TUNERS—NEW	
Sylv. Trans. 54-29331-3	\$6.95
Sylv. Trans.—54-35055-2	\$6.95
PHILCO Trans. 76-14296-2	\$6.95
GEN ELECT. Trans. 86X15	\$6.95
G. I. Parallel 6GS7-6HA5	\$3.95
Philco Series 5GJ7-3HQ5	\$3.95

BSR CHANGER-STEREO	\$15.95
CASSETTE TAPE—c-60	2 for \$1.19
CASSETTE TAPE—C-120	2 for \$2.29
10 RCA Phono Plugs	\$1.00

CONDENSERS—AXIAL LEADS	
100 Mfd.-150 Volts	10 for \$1.98
10 Mfd.—450 Volts	6 for \$1.49
10 Mfd.-600 Volts	3 for \$1.00
25 Assorted Condensers	\$4.95

TUBES—ICC—RAYTHEON	
25-6GH8	\$17.50
5—2AV2	\$4.50
5—6FQ7	\$4.25

MINIMUM ORDER \$15.00
SEND FOR FREE CATALOG
TUBES UP TO 80% OFF
SEND CHECK OR
MONEY ORDER

TV TECH SPECIALS

P.O. Box 603 ES-10
Kings Park, L.I., N.Y. 11754
(516) 757-2115

For More Details Circle (15) on Reply Card

service breakthrough

Guesswork is gone!...

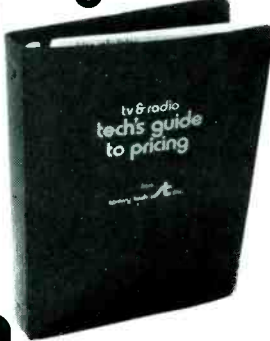

in flat rate pricing!

Now, for the first time, one compact book guides you through the pricing hazards encountered in today's major categories of TV and radio repair. No more guesswork. The building block system automatically provides an accurate pricing method for each step or adjustment involved. Each step is priced according to its complexity or magnitude. Also, there's a bonus section in the book that provides new business planning insight, that gives you an edge in all areas of pricing. **It's simple to use!** 1...index to the product repair. 2...total times for each repair. 3...convert time to price on the calculator page. (converts time to price in any area of the U.S.). Order now! A must for every shop owner...**Don't delay another profit day** simply fill out and mail the coupon below.

\$18⁰⁰ per issue, postpaid.

(Nebr. residents add city and state sales tax)

tv & radio
tech's guide
to pricing

sperry tech inc.

P.O. Box 5234

More information please. Lincoln, NE. 68505

My check or money order enclosed.

NAME _____
COMPANY _____
ADDRESS _____
CITY _____ STATE _____ ZIP _____

For More Details Circle (16) on Reply Card

52

productreport

(Continued from previous page)

for Type I heavy-duty use according to the standards of the American National Safety Institute, yet they are light enough for easy one-man handling. Prices start at \$47.95 for the 12-foot straight ladder and range to \$169.95 for the 40-foot extension ladder.

For More Details Circle (47) on Reply Card

Contact Cleaner

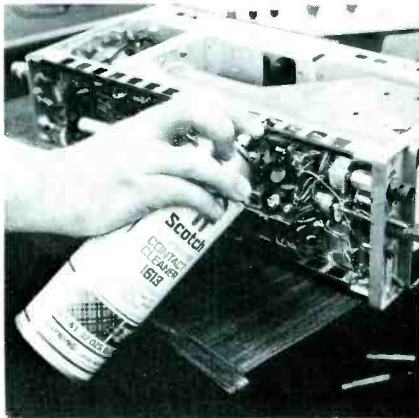

A non-flammable, non-crazing contact cleaner that is harmless to most plastics has been developed by the **Electro Products Division of 3M Company**. "Scotch" brand premium contact cleaner 1613 is designed for cleaning switches, brushes, solenoids, generators, circuit breakers, computer heads, and gold and low-voltage contacts. It dries instantly and leaves no residue to interfere with electrical properties.

For More Details Circle (48) on Reply Card

Wiring Tools

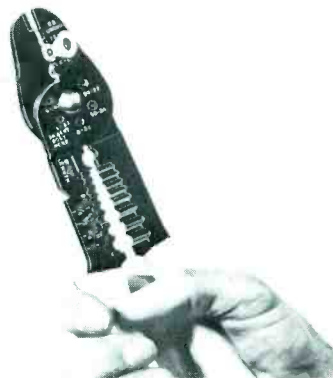

Vaco Products Company has introduced the Wireplier, a wiring tool and crimper. The tool features a crimping die for 6 and 8 gauge non-insulated terminals, a 7mm crimping die for ignition terminals, stripping dies for 6 and 8 gauge wire, and measurement markings for bolts and wire strip

length. The Wireplier measures 8-7/8-inches long, with black oxide finish and cushion grip handles. It sells for \$7.95.

For More Details Circle (49) on Reply Card

Storage Wall

An improved storage wall with high-strength drawers to withstand heavy loads or rough treatment has been introduced by the **Hallowell Division of Standard Pressed Steel Company**.

The 1100 series storage wall features a slot-and-rib arrangement in the drawer that locks dimpled drawer dividers into place, preventing them from coming apart. The storage wall comes in models containing 12, 14, 16, 18, 24, 28, and 32 drawers, 11 or 17 inches deep. Drawers are available in sizes 2-5/8 or 1-3/4 inches high and can be 5-1/4 or 8 inches wide.

For More Details Circle (50) on Reply Card

Components Kit

The **XL-100 Components Kit** number 199006 contains a variety of transistors, diodes and resistors, plus one circuit breaker, totalling 29 components. Also included is a tube of white silicone heat-sink compound. The kit features a parts location diagram and a separate cross-reference chart. The diagram, which fits into the kit lid, simplifies parts identification by showing the exact location of each component in the kit; the cross-reference chart shows usage of each part by chassis number and circuit-symbol number.

Available from **RCA Parts and Accessories**, the XL-100 components kit sells for \$59.60.

For More Details Circle (51) on Reply Card

For More Information
On Items Advertised
Use Our
Reader Service Cards

DISTRIBUTOR OF EUROPEAN ELECTRONIC PARTS

TELEFUNKEN • BLAUPUNKT • GRUNDIG •
METZ • NORELCO • KORONETTE • PHONO-
SONIC • LION • KUBA • KAISER • IMPERIAL •
PE • DUAL • NORMENDE AND MANY OTHERS

GERMAN ELECTRONICS SERVICE CORP.
63-04 39th Ave. P.O. Box 266
Woodside, N.Y. 11377
Tele. (212) TW9-3900

For More Details Circle (26) on Reply Card

FREE ALARM CATALOG

Full line of professional burglar and fire alarm systems and supplies. 96 pages, 450 items. Off the shelf delivery, quantity prices.



mountain west alarm
4215 n. 16th st., phoenix, az. 85016

For More Details Circle (31) on Reply Card
ELECTRONIC SERVICING

antenna systems report

These features supplied by the manufacturers are listed at no-charge to them as a service to our readers. If you want factory bulletins, circle the corresponding number on the Reply Card and mail it to us.

Directional Coupler Taps

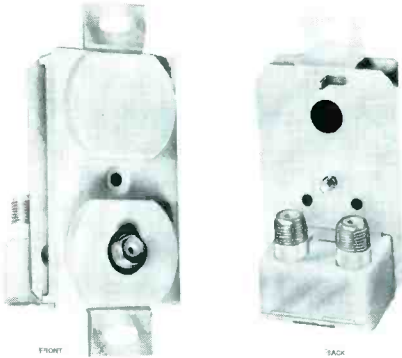

Jerrold Electronics has developed a new series of directional coupler flush-mounted tap-offs for use with either an MATV head-end or a CATV feed. The DFT series is compatible with 30 channel 2-way service, sur-

endeco Soldering and Desoldering KITS



Model 500K
12-piece
desoldering kit
\$21.55 NET

- Soldering kits • Desoldering kits
- Soldering-Desoldering kits

Everything needed to solder or desolder, or both. Featuring new Endeco soldering and desoldering irons with safety light... the irons professionals really appreciate. Tips, stand, desoldering head and cleaning tool included, as required, all in a metal box with hasp. \$21.55 to \$39.65.

To locate your nearest distributor
call toll-free 800-645-9200



5127 EAST 65TH ST.
INDIANAPOLIS,
INDIANA 46220
PHONE 317/251-1231

enterprise
development
corporation

For More Details Circle (17) on Reply Card

passing FCC technical specifications. Five values of uniform tap isolation are available: 7 dB, 13 dB, 19 dB, 25 dB, and 31 dB. Directionality is 16 dB, 5 to 300 MHz; minimum isolation between outlets is 30 dB. While the 7 dB isolation DFT passes 5 to 300 MHz, the 13, 19, 25, and 31 dB units handle 5 to 806 MHz, with directionality of 10 dB minimum through the UHF band.

For More Details Circle (52) on Reply Card

VHF Log Periodic Antenna

Model ASP-810 provides a minimum of 8.1 dB forward gain across a 26-MHz bandwidth, from 148 to 174 MHz. VSWR is less than 1.5:1 across the entire bandwidth; front-to-back ratio is rated at greater than 20 dB. Other features include a 500-watt power handling capability and DC grounding for lightning protection. Model ASP-810 is available from **The Antenna Specialists Company**.

For More Details Circle (53) on Reply Card

Distribution Amplifiers

Antenna Corporation of America is offering the Mini-Mite series of distribution amplifiers. Model HS-187 (82-channel) and Model HSV-17 (VHF-FM) cover the mid-band and super-band. Compatible with CATV systems, they eliminate the extra charges for more than one set in a home that is connected to a cable system.



Model HS-187 puts out over 1 volt with an input of 200,000 MV; the HSV-17 has a 1.4-volt output and a 250,000 MV input. Both units can be used as line extenders or line amplifiers in large MATV systems. Dimensions are 1-1/2 X 4-1/2 X 5-1/2 inches. Model HSV-17 sells for \$34.50 and Model HS-187 for \$42.95.

For More Details Circle (54) on Reply Card

GIVE THE UNITEDWAY



T & T VALUE SALE

RAY, I.C.C., RCA, SYL.
FAMOUS MAKES—NEW JOBBER BOXED

- 85% OFF LIST
- | | | | |
|-------------------------------|---------------|--------------------------------|---------------|
| <input type="checkbox"/> 3D7E | 10 for \$5.55 | <input type="checkbox"/> 12D78 | 10 for \$6.00 |
| <input type="checkbox"/> 3C86 | 10 for \$4.57 | <input type="checkbox"/> 25B06 | 10 for \$6.60 |
| <input type="checkbox"/> 5B3C | 10 for \$5.78 | <input type="checkbox"/> 35Z5 | 10 for \$5.62 |
- *Famous Make New Jobber Boxed Tubes
6GH8 Special 100 for \$55.00

FAMOUS MAKE—NEW JOBBER BOXED

- 80% OFF LIST
- | | | | |
|-------------------------------|--------------|------------------------------------|--------------|
| <input type="checkbox"/> 3A3 | 5 for \$4.55 | <input type="checkbox"/> 6GH8 | 5 for \$3.55 |
| <input type="checkbox"/> 3GK5 | 5 for \$4.35 | <input type="checkbox"/> 6GF7 | 5 for \$5.95 |
| <input type="checkbox"/> 3HM5 | 5 for \$4.30 | <input type="checkbox"/> 6GM6 | 5 for \$4.35 |
| <input type="checkbox"/> 5GH8 | 5 for \$5.30 | <input type="checkbox"/> 6GY6 | 5 for \$3.85 |
| <input type="checkbox"/> 6BK4 | 5 for \$8.35 | <input type="checkbox"/> 6HB7 | 5 for \$4.85 |
| <input type="checkbox"/> 6CG3 | 5 for \$4.40 | <input type="checkbox"/> 6HA5 | 5 for \$4.30 |
| <input type="checkbox"/> 6C13 | 5 for \$4.20 | <input type="checkbox"/> 6JC6 | 5 for \$5.05 |
| <input type="checkbox"/> 6EA8 | 5 for \$4.40 | <input type="checkbox"/> 6JS6 | 5 for \$8.30 |
| <input type="checkbox"/> 6EH7 | 5 for \$4.30 | <input type="checkbox"/> 6LQ6/GJE6 | 5 for \$9.95 |
| <input type="checkbox"/> 6EJ7 | 5 for \$4.05 | <input type="checkbox"/> 12BY7 | 5 for \$4.05 |
| <input type="checkbox"/> 6F07 | 5 for \$3.35 | <input type="checkbox"/> 50C5 | 5 for \$3.40 |

I.C.C. NEW JOBBER BOXED ODDBALLS

- 77% OFF LIST
- | | | | |
|--------------------------------|--------------|--------------------------------|---------------|
| <input type="checkbox"/> 3BS2 | 5 for \$5.45 | <input type="checkbox"/> 6HB5 | 5 for \$6.00 |
| <input type="checkbox"/> 3CN3 | 5 for \$5.25 | <input type="checkbox"/> 6LR8 | 5 for \$6.20 |
| <input type="checkbox"/> 5GJ7 | 5 for \$3.70 | <input type="checkbox"/> 6IA5 | 5 for \$5.80 |
| <input type="checkbox"/> 5MB8 | 5 for \$4.60 | <input type="checkbox"/> 16A03 | 5 for \$3.40 |
| <input type="checkbox"/> 6AF11 | 5 for \$6.75 | <input type="checkbox"/> 21HB5 | 5 for \$6.20 |
| <input type="checkbox"/> 6BE3 | 5 for \$5.85 | <input type="checkbox"/> 31J56 | 5 for \$9.35 |
| <input type="checkbox"/> 6DN3 | 5 for \$4.50 | <input type="checkbox"/> 31L26 | 5 for \$11.55 |

TRANSISTORS XACT REPLACEMENT

- 80% OFF LIST
- | | | | |
|---------------------------------|--------------|----------------------------------|---------------|
| <input type="checkbox"/> SK3004 | 5 for \$1.90 | <input type="checkbox"/> SK3036 | 5 for \$9.75 |
| <input type="checkbox"/> SK3006 | 5 for \$2.35 | <input type="checkbox"/> SK3040 | 5 for \$3.75 |
| <input type="checkbox"/> SK3009 | 5 for \$3.90 | <input type="checkbox"/> SK3054 | 5 for \$4.50 |
| <input type="checkbox"/> SK3010 | 5 for \$3.10 | <input type="checkbox"/> SK3114 | 5 for \$2.40 |
| <input type="checkbox"/> SK3018 | 5 for \$2.25 | <input type="checkbox"/> SK3124 | 5 for \$2.10 |
| <input type="checkbox"/> SK3024 | 5 for \$3.15 | <input type="checkbox"/> SK3132 | 5 for \$2.60 |
| <input type="checkbox"/> SK3025 | 5 for \$4.50 | <input type="checkbox"/> Hep 707 | 5 for \$15.00 |
- Matching pair PNP-NPN-2N4079
(ECG 131, ECG 151) 4 pairs for \$7.80

ANTENNAS

- | | |
|--|---|
| <input type="checkbox"/> Piggy Back Antenna | <input type="checkbox"/> 100 for \$149.00 |
| | <input type="checkbox"/> 20 for \$15.00 |
| <input type="checkbox"/> 2 Set 72 ohm Coupler | \$1.95 |
| <input type="checkbox"/> 4 Set 72 ohm Coupler | \$2.95 |
| <input type="checkbox"/> 72-300 ohm UHF VHF Splitter | 2 for \$2.00 |
| <input type="checkbox"/> 300 ohm UHF VHF Splitter | 2 for \$1.50 |
| <input type="checkbox"/> 72-300 ohm Coupler | \$1.95 |
| <input type="checkbox"/> 300 ohm 4 Set Coupler C014 | 10 for \$10.00 |
| <input type="checkbox"/> JFD BC2 2 Set Coupler | \$1.50 |
| <input type="checkbox"/> AC Plug in Antenna | 5 for \$5.00 |
| <input type="checkbox"/> 59U Coax F Connectors | 100 for \$10.00 |

SPECIAL

- Mag. Color Chassis incl. tuner, flyback, power transformer, tubes, engineering models—As is \$39.95

AUDIO

- | | |
|---|---------------|
| <input type="checkbox"/> 60 Min. Cassette Tapes Irish | 6 for \$2.50 |
| <input type="checkbox"/> 84 Min. 8-Track Irish Tape | 3 for \$3.00 |
| <input type="checkbox"/> Equiv. Shure Needles <input type="checkbox"/> N44 <input type="checkbox"/> N75 | |
| <input type="checkbox"/> N77 <input type="checkbox"/> N91 | ea. \$2.95 |
| <input type="checkbox"/> Equiv. Pickering V15 | ea. \$2.95 |
| <input type="checkbox"/> Carded Sapphire Needles: BSR, Ast., G.E., Tetrad, Varco, Panasonic, Mag. | 12 for \$3.95 |

YOKES—TUNERS—FLYS

- | | |
|--|---------------|
| <input type="checkbox"/> Jap Color Fly | \$3.95 |
| <input type="checkbox"/> Jap B&W Fly | \$1.95 |
| <input type="checkbox"/> Tuner inc. 6GS7, 6HA5 | \$2.95 |
| <input type="checkbox"/> Combo Tuners inc. tubes | \$4.95 |
| <input type="checkbox"/> Y105 <input type="checkbox"/> Y94 | \$7.95 |
| <input type="checkbox"/> Y109 w/o b/c | 3 for \$10.00 |
| <input type="checkbox"/> Zen. 95-2874 Y130 | 5 for \$25.00 |
| <input type="checkbox"/> Zen. 95-2779 Yoke | 2 for \$10.00 |
| <input type="checkbox"/> Zen. Golden Grid Color Tuner (includes tubes) Assort. | 4 for \$26.00 |
| <input type="checkbox"/> Zen. B/W Assort. | 4 for \$18.00 |

GENERAL

- | | |
|---|---------------|
| <input type="checkbox"/> Color Conv. Assy | ea. \$1.95 |
| <input type="checkbox"/> 19 & 25" <input type="checkbox"/> 21" Color Boosters | 3 for \$11.95 |
| <input type="checkbox"/> 2.5 Amp 1000 PIV IR170 | 20 for \$3.50 |
| <input type="checkbox"/> 6500 PIV ITT Focus Rect. | 10 for \$5.00 |
| <input type="checkbox"/> Zen. voltage Triplers 212-136 | 3 for \$12.00 |
| <input type="checkbox"/> 3.58 crystal Osc. | 4 for \$3.00 |

Minimum Orders \$35—F.O.B. Brooklyn, N.Y.
Catalogs \$1—Refundable Upon Your Order.

T & T SALES CO.

4802 AVENUE K
BROOKLYN, N. Y. 11234

Phone: (212) 241-5940

For More Details Circle (18) on Reply Card 53

Telephone Amplifier



Saxton Products, Inc. has introduced a Hands-Free Telephone Amplifier. The solid-state, instant-on, all-transistorized pick-up and speaker system amplifies the voices of all parties conversing on the telephone. The unit is said to supply 30% more usable amplification than most existing models. A pressure-activated switch on the amplifier unit automatically turns the amplifier on and off with placement and removal of the handset, thus assuring extended battery life. The amplifier unit measures 4 X 8 inches; the speaker unit is 3-1/2 X 4-1/4 inches.

audio systems report

These features supplied by the manufacturers are listed at no-charge to them as a service to our readers. If you want factory bulletins, circle the corresponding number on the Reply Card and mail it to us.

The Hands-Free Telephone Amplifier sells for \$19.95.

For More Details Circle (55) on Reply Card

FM Transmitter



Designed for home or professional use, the Remota is a low-cost, battery-powered, low-power FM transmitter which can be used to

"broadcast" music from a stereo system (either tapes or records), a TV set, or a musical instrument to a maximum distance of 300 feet from the transmitter.

The Remota plugs into the stereo headphone output, line output, or earphone jack of a TV set, and the broadcast signal is received on any FM radio in the home, portable or plug-in, within its broadcast maximum of 300 feet.

Available from **Enkay Engineering and Equipment Company**, the Remota FM transmitter sells for \$34.50.

For More Details Circle (56) on Reply Card

Loudspeaker

Altec Corporation is offering the 891A Stonehenge I, a floor-standing loudspeaker that features a 12-inch high-compliance, low-frequency speaker, a precision dividing network, and a direct-radiator tweeter.

The loudspeaker is a medium-efficiency speaker designed for use with amplifiers capable of delivering a minimum of 25 watts of continuous average power per channel. Dimensions are 37-1/2 X 16 X 14-1/2 inches. The 891 Stonehenge I sells for \$329.00.

For More Details Circle (57) on Reply Card

WINEGARD AMPLIFIED PRODUCTS PROVEN IN OVER 1,000,000 INSTALLATIONS.

CASE IN POINT: WINEGARD DISTRIBUTION AMPLIFIERS.



For quality and dependability in distribution amplifiers, look to Winegard. You know they're good. Because our distribution amplifiers have specs you can count on and the best reliability in the industry today.

When you install an MATV system you want it to work right . . . and keep on working that way. You want a headend amplifier that won't give you headaches. No matter what size systems you install Winegard offers the most trouble-free circuitry around . . . and at the most reasonable cost around.

On your next commercial system start out with a Winegard distribution amplifier. There's a model just right for every size and type of installation. We invite comparison!

Best TV products for Best TV reception

WINEGARD
TELEVISION SYSTEMS

Winegard Company • 3000 Kirkwood Street • Burlington, Iowa 52601

For More Details Circle (19) on Reply Card



New goodies add measure power to Fluke 8000A

Best selling 3½ digit DMM
even better with new options
and accessories

New ac/dc high current option lets you measure up to 20A. New low 2 and 20 Ω scales give 0.001 Ω resolution. Low cost RF probe offers new capability.

Other options include rechargeable battery pack, digital printer output, deluxe test leads, 40 kV high voltage probe, 600 A. ac current probe, carrying cases, dust cover and rack mount.

Basic "best buy" \$299 DMM feature dc accuracy of 0.1%. Measure ac/dc volts from 100 μv to 1200 v, current from 100 nanoamperes to 2 A. and resistance from 100 milliohms to 20 megohms. Guaranteed 20,000 hour MTBF.

FLUKE
®

For data out today,
dial our toll-free hotline,
800-426-0361

John Fluke Mfg. Co., Inc., P.O.
Box 7428, Seattle, WA 98133

For More Details Circle (20) on Reply Card
For Demonstration Circle (32) on Reply Card

catalogs literature

Circle appropriate
number on Reader
Service Card.

101. Brookstone Company—offers its second 1974 catalog of hard-to-find tools. The 60-page catalog features 76 new products in addition to the thousands of other items available from the firm.

102. International Rectifier Corp.—makes available a handy, pocket-sized universal-replacement transistor crossover chart, which lists over 250 IR and competitive part numbers. The 8-1/2 X 3-1/2 inch card allows the user to select the proper IR universal transistor to replace universal transistors made by other major suppliers, including Sylvania, RCA, GE, and Motorola.

103. Nortronics Company—has introduced a ten-page, two-color brochure describing their line of Recorder Care Kits. Included are ToteKits 1, 2, and 3 for cassette, 8-track cartridge, and reel-to-reel recorders and players, respectively; Inspection and Cleaning Kits QM-6, 7, 8 and 9 for all machine types; and QM-5 Video Recorder Care Kit for video tape recorders.

104. Perma Power—has released a six-page, illustrated catalog of solid-state public-address sound systems. The catalog describes the complete line of Ampli-Vox equipment, covering almost all applications for portable sound systems. A comprehensive range of accessory items are also listed.

105. Projector Recorder Belt Corp.—offers a catalog listing over 1800 belts available from stock for tape recorders, projectors, record players, dictating machines, and video recorders. A simplified cross-reference system combined with a special belt sizer makes ordering easy and reduces inventory for service and repair shops.

106. RCA Parts and Accessories—makes available a 16-page catalog of servicing aids for electronic technicians, featuring the RCA Indus-

try-Compatible Test Jig Program. The manual includes seven pages of photos to help identify the cables and adapters utilized with the test jig, as well as a comprehensive cross-reference chart. Descriptions of other RCA products and accessories are also included.

107. Simpson Electric Company—has released a 108-page Master Catalog containing comprehensive technical information on panel meters, meter relays, controllers, recorders, digital instruments, and test equipment. In loose-leaf form, the catalog is bound in a durable, hard cover, 3-ring binder for easy data change.

108. Sprague Electric Company—has introduced a comprehensive revision of their Semiconductor Manual and Replacement Guide. The new 64-page Manual K-500A lists over 38,000 of the most popular domestic and foreign OEM semiconductor part numbers and their recommended replacement with 137 of Sprague's RT, TVCM, and ZT series semiconductors. All listings are alpha-numerical for simplified use of the manual. Also included is an extensive product guide section.

109. Tab Books—offers its 1974 catalog, describing over 300 current and forthcoming books, plus 14 Electronic Book/Kits. Subject areas include basic electronics technology, CATV and MATV, medical electronics, radio receiver servicing, television servicing, test equipment, communications and CB radio, and transistors and semiconductors.

110. Telematic—makes available their 1974 catalog of test jigs, replacement parts and service accessories. The 16-page catalog offers many new items for the service market.

111. Triplett Corp.—has introduced an eight-page, four-color brochure on its new line of sound measuring, monitoring, and recording equipment. "A Better Way To See Sound" illustrates Triplett's sound level meters, dosimeter, integrator, calibrators, and accessories. It provides detailed physical and electronic specifications, including dimensions, weights, decibel ranges, per-

formance parameters, operating characteristics, and environmental considerations, and has tables showing typical sound pressure levels generated by various industrial and other operations. □

Need drive tires ...wheels?



WE'VE THOUSANDS IN STOCK

Tires . . . wheels and drive belts for over 1900 makes and models of tape recorders, dictating machines, projectors and video recorders . . . and if it isn't in stock chances are that we can duplicate it quickly and inexpensively. Eliminate over-stocking of interchangeable parts. Eliminate replacing entire assemblies, when all you need is the drive tire. Most parts are available for same day shipment on orders of one or two . . . or hundreds! SPECIAL OFFER . . . free sample drive tire or wheel of your choice (send old part and make/model information). FREE catalog/cross-reference chart included. Write or call today.

**PROJECTOR-RECORDER
BELT CORPORATION**
311 Whitewater St., Whitewater, Wis.
53190 414/473-2151

For More Details Circle (21) on Reply Card

FREE CATALOG

HARD-TO-FIND PRECISION TOOLS

Lists more than 2000 items—pliers, tweezers, wire strippers, vacuum systems, relay tools, optical equipment, tool kits and cases. Also includes ten pages of useful "Tool Tips" to aid in tool selection.

JENSEN TOOLS

4117 N. 44th Street, Phoenix, Ariz. 85018

For More Details Circle (22) on Reply Card

MINI-BAR®

color generator

\$89.50

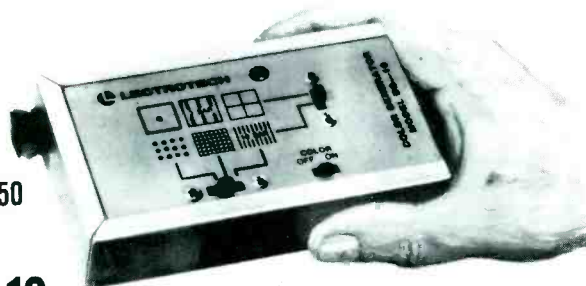

BG-10 battery-operated, fits in shirt pocket!

No AC plug in . . . automatic on & off with LED indicator . . . fast, easy hook-up with coaxial cable . . . all essential patterns . . . • Low power consumption for extended battery life (Uses inexpensive 9 volt batteries) • Shuts off when not in use • Enclosed RF cable compartment • Size: 5 1/2" x 3" x 1 1/8". Only 12 ounces • TV station type sync signals • CMOS LSI IC for all counting functions . . . no internal adjustments • RF output on Ch. 4 or 5.

BG-10 (less battery) \$89.50
CC-1 Carrying Pouch \$ 2.95



See your distributor or write

LECTROTECH, INC.

5810 N. Western Ave.,
Chicago, Illinois 60659
(312) 769-6262



Available in Canada
from
Superior Electronics
Inc.

For More Details Circle (23) on Reply Card

LOOK TO *Lenk*

FOR YOUR SOLDERING TOOLS



You'll find the right product at the right price in the Lenk line — made by long-time specialists in soldering equipment.

CORDLESS

Battery powered. Built-in light. Fits easily into a tool box. Can be used while re-charging. Over 700°F tip temperature. Heats almost instantly. Very light — very useful!



PENCIL TYPE IRONS

Lightweight, cool handles, screw-in tips

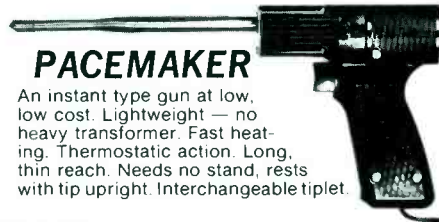

PACEMAKER

An instant type gun at low, low cost. Lightweight — no heavy transformer. Fast heating. Thermostatic action. Long, thin reach. Needs no stand, rests with tip upright. Interchangeable tiplet.

AND OTHERS —

ALL MADE IN THE U.S.A. BY SKILLED CRAFTSMEN
See the Lenk line where quality soldering tools are sold

SINCE 1864

WALL-LENK MFG. CO.

WORLD'S LARGEST MANUFACTURER OF SOLDERING IRONS
KINSTON, N. C. 28501

For More Details Circle (24) on Reply Card

photofactbulletin

PHOTOFACT BULLETIN lists new PHOTOFACT coverage issued during the last month for new TV chassis.

ADMIRAL
Chassis M2505-1, M2508-1, M2512-1 1429-1

ADMIRAL
Chassis 3M2011-2, 3M2019-1/-2/-4 1434-1

BRADFORD
1007B32/C32/D42
(WTG-51706/714/722) 1435-1

BRADFORD
1105A45/B45/C45 (WTG-80671A/689A/697A) 1433-1

BROADMOOR
2019 1429-2

BROADMOOR
2509 1430-1

CATALINA
122-4010 1435-2

J. C. PENNEY
2344 (685-2344) 1432-1

MAGNAVOX
Chassis T984-01-ZA/-02-ZA/-03-ZA/-04-ZA 1431-1

PANASONIC
Chassis T125A, T126A 1434-2

PHILCO-FORD
Chassis 4CY80 1430-2

RCA
Chassis CTC71J 1435-3

SEARS
363.50000400, 363.50030400,
363.50050400, 363.50060400,
363.50070400 1433-2

SONY
KV-1722 (Ch. SCC-41A-B) 1432-2

SYLVANIA
Chassis EO6-1, EO6-2 1432-3

TELEDYNE
Chassis 98C47 1431-2

TRUETONE
WEG2597A-57/99A-57 1430-3

WARDS AIRLINE
GAI-12103A/103B/104A/114A/253A/253B/253C/
633A/633B/634A/663A/663B/683A/683B/
684A/693A/693B, R200R (750A1462-1),
R204T (750A1462-6) 1434-3

WARDS AIRLINE
GAI-13133A/33B/33C/33D/34A/34B,
GAI-13994A, GAI-14823A/23B/43A/
43B/53A/53B, GCI-13162A 1429-3

bookreview

Electronic Flash Equipment

Author: Verl Mott

Publisher: Howard W. Sams & Co., Inc., 4300 West 62nd Street, Indianapolis, Indiana 46268

Size: 5-1/2 X 8-1/2 inches, 112 pages

Price: \$4.50 softbound

This book provides a single-source guide to understanding the operation and servicing of flash/strobe equipment. Chapter 1 discusses electronic flash equipment with emphasis on single-flash units, multiflash units, and stroboscopes. After covering the basic flash units, the author explains flashtubes, triggering circuits, power sources, and power storage. The final chapter includes topics such as servicing the power source and power storage sections, servicing the flash head, silicon photodiodes, and silicon controlled rectifiers. The text is supported by numerous illustrations, and the appendix provides a list of electronic flash equipment manufacturers.

Electronic Security Systems

Author: Leo G. Sands

Publisher: Audel Division, Howard W. Sams & Co., Inc., 4300 West 62nd Street, Indianapolis, Indiana 46268

Size: 5-1/2 X 8-1/4 inches, 288 pages

Price: \$5.95 hardbound

Written to meet the demand for more information about security systems, the book begins with a discussion of the scope and application of security systems. Subsequent chapters deal with topics such as switches and relays, sensors and encoders, indicators and alarms, electrical and electronic control and alarm circuits, closed circuit television, and transmission media. A chapter on security communications covers automatic telephone dialers, call diverters, private telephone systems, wired intercoms, and emergency radio communications. The last chapter states the criteria for security system design and describes system installation and maintenance practices. The book is written in easy-to-understand language and features numerous illustrations. □

If you've recently run across an unusual trouble symptom and have determined what caused it, why not pass the info on to the other readers of ELECTRONIC SERVICING. You'll not only be saving other technicians valuable troubleshooting time, you'll also be making a little extra change for yourself. Send a thorough description of the trouble symptom and the solution to:

Troubleshooting Tips, ELECTRONIC SERVICING
1014 Wyandotte Street, Kansas City, Missouri 64105

MAGIC COLOR ANTENNAS Sales Orbit

THROUGH:

- ★ Higher Profit
- ★ Sales Captivating Packaging
- ★ Excellent Quality
- ★ Full Range Of Models



APOLLO

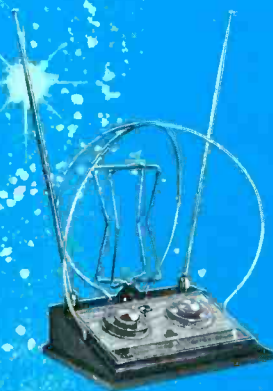

GALAXY



VENUS



SATURN

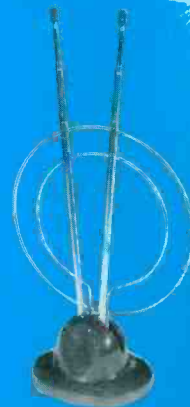

GC ELECTRONICS

DIVISION OF HYDROMETALS, INC.
ROCKFORD, ILLINOIS 61101 U.S.A.



SERVICE ASSOCIATIONS



Dick Glass (at podium) has just presented Vincent J. Lutz with a plaque signifying his induction into the NESDA Electronics Hall of Fame. At right is C. Bryson Bush, the master-of-ceremonies, who is a member of the Hawaii Television Service Association.

New officers elected at the August NESDA convention held at the Kauai Surf Hotel in Hawaii included: Charles R. Couch, Jr., President; Jack Kelly, Treasurer; Virgil Gaither, Secretary; Leroy Ragsdale, Senior Vice President; and Richard R. Glass, Executive Vice President. These are the IS CET officers: Larry Steckler, Chairman; Bob Cook, Vice Chairman; Jesse B. Leach, Jr., Treasurer; and Gordon W. Turnbull, Secretary. More NESDA convention news will be given next month.

Charles R. Couch, Jr., past President and newly re-elected President of NESDA is shown receiving the "Outstanding National Officer" award for the year from Dick Glass, NESDA Executive Vice President.



Members of Hawaii Television Service Association welcomed most flights carrying NESDA members arriving in Hawaii for the annual convention.



Utah Professional Electronics Association recently became the 30th state association to join NESDA. Pictured is part of the crowd at a business-management school in Provo, Utah, sponsored by four distributors and conducted by Dick Glass, Executive Vice-President of NESDA. In the striped sweater is Keith Brickey, new President of UPEA.



We regret that the photos and information about the NATESA convention in Chicago did not reach us in time to be included. We promise full coverage next issue. □

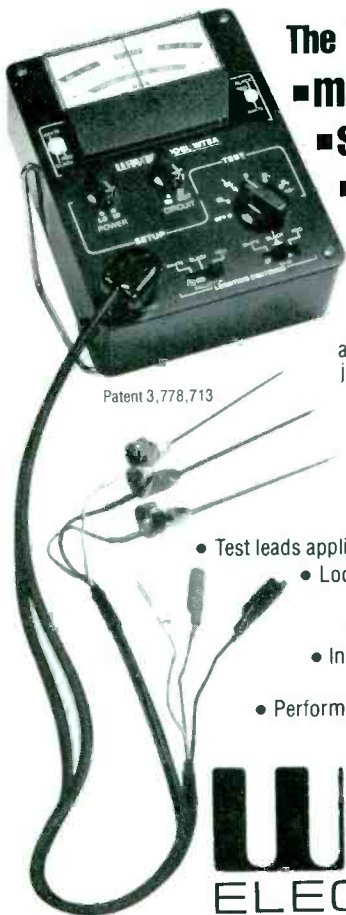

The Wayne Model WT2A

- makes YOU money
- saves much time
- makes troubleshooting easier

A new concept in transistor testing based on proven methods of circuit analysis. A current limited AC voltage is applied to each semiconductor junction under test. The resulting DC voltage is monitored while the rectifying junction is passing normal rated current. Abnormalities are easily identified.

- Indicates PNP or NPN
- Measures relative gain
- Test leads applied without prior basing knowledge
- Locates base and collector during test
 - Indicates silicon or germanium
 - Indicates transistor non-linearity
- In-circuit tests with shunt impedance down to THREE ohms
- Performs all of above and more in less than ten seconds

WAYNE ELECTRONICS

5412 Nordling St./Houston, Texas 77022

For More Details Circle (25) on Reply Card

Test Lab

(Continued from page 37)

being tested on the 2000 range, and reading 461. Move the decimal three numbers to the left, and the result is .461 microfarad. Or it could be read 461,000 pF.

The second precaution is that leakage in the capacitor (or external circuit leakage) increases the reading as though the capacitance was much higher. For example, a .001 capacitor read .00133 on the 20 range when there was no leakage. A leakage of 2.2 megohms increased the reading to .00356. However, the larger the capacitance, the less effect the same amount of leakage has. A .1 capacitor read .0945 on the 200 range without leakage, and .0988 with 2.2 megohm leakage.

Therefore, it is essential for accuracy of capacitance readings that you check for leakage first. That's a small price to pay for the convenience of direct reading of capacitance.

Comments On The Model 21 DMM

At this writing, I am still using and enjoying the Data Technology Model 21 DMM.

Because the A/D converter is said to be of the Unislope (single ramp) type, I was concerned that RF carriers and hum might destroy the accuracy of the readings. **That didn't happen.** The DMM was used within a block of a powerful TV antenna, near the horizontal-sweep section of a color TV, and a few blocks from an AM broadcast station without the slightest indication that these signals had any effect at all on the readings.

The digital multimeter operated accurately and reliably, with a maximum of convenience. The only exceptions were my mistakes in forgetting to change the test lead. □

Tube Replacements

(Continued from page 32)

tubes are in the same category as "fountains of youth," and in this context, rejuvenation is impossible. But, a picture tube costs the user more than \$200 installed, or about \$40 per year of use. If rejuvenation extends the life of the tube for six months or more, it may

be worth the cost to the user. To the technician, "A little business is better than no business at all", and he is more likely to get the picture-tube replacement job when it is necessary sometime later.

Brighteners

The brightener, like the rejuvenator, cannot make a new picture tube out of an old one. In many cases, it **can** extend the useful life of the tube. The brightener simply increases filament voltage to increase emission — the same method used by some rejuvenators. After a day or two of operation with a brightener, many tubes will operate well without it for several months.

Summary

A picture-tube replacement is a major expenditure for many people, and a "big-ticket" service job. A replacement which does not solve the problem is a costly experience for the technician. This can be avoided by making certain (before the original is removed) that a new tube will restore normal reception.

When insufficient light output is the symptom, you can eliminate suspicion of most of the external circuits by using a tube tester. This is far simpler than measuring all the voltages fed to the tube. The effects of abnormal voltages, and some possible causes for them, have been outlined here for those instances when the picture tube is good and further troubleshooting is necessary.

Convenient as it is, the picture-tube tester will not check for faults involving convergence, purity, and (usually) focus. These are apparent only in operation of the receiver. Nor are these symptoms necessarily caused by the picture tube itself. Troubles in the surrounding circuitry can cause these same symptoms.

Installing replacement color picture tubes can be very profitable, if you diagnose correctly. □

SCR-Sweep Defects

(Continued from page 21)

at high brightness produced a strong electrostatic field, which entered the horizontal module when the shield was missing and modul-

ated the phase. **Shields usually are included for good reasons, and we should be careful to replace them.**

Summary

For in-home service, first replace any modules that might cause the symptoms. For horizontal-sweep problems, install new SCR101, SCR102, CR1, CR2, and C6 (or equivalent numbers in other schematics). Perhaps 80% of the horizontal defects will be repaired by these two steps.

Other steps include defeating the disable circuit to check for regulation problems (see Figure 9), grounding point "L" to see if that stops the breaker from tripping, and paralleling the first two filters of the 155-volt supply.

If the chassis is brought to the shop, repeat those tests to make sure they were done properly.

In case the trouble does not show up right away, increase the line voltage to 130. This helps in two ways. First, the line voltage in the customer's home might be above the normal 120, and the higher voltage will more nearly establish the home conditions. Also, receivers without the backs in place, or chassis without cabinets on the bench, tend to run cooler. Higher line voltage makes the circuits run warmer. There is no real danger of operating these sets for a **short** time at the higher voltage, although certainly it's not recommended for longer periods.

If there is difficulty in operating the receiver for tests because the breaker trips too often, reduce the line voltage. It might surprise you to know how low the voltage can be and still permit a raster. For example, a normal CTC48 chassis at a line voltage of 60 will have a dim raster with about 3 inches of black at each edge. Obviously, operation at 75 or 95 volts produces a larger, brighter picture than that.

Waveform analysis, especially of the gate signals of both SCR's, can be very helpful in solving difficult problems. □

OWN YOUR OWN PICTURE TUBE REBUILDING BUSINESS

With Lakeside Industries rebuilding equipment you can rebuild any picture tube!

For complete details send name, address, zip code to
LAKESIDE INDUSTRIES
3520 W. Fullerton Ave.
Chicago, Ill. 60647
Phone: 312-342-3399

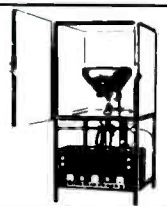

For More Details Circle (27) on Reply Card

The MARKETPLACE

This classified section is available to electronic technicians and owners or managers of service shops who have for sale surplus supplies and equipment or who are seeking employment or recruiting employees.

Advertising Rates
in the Classified
Section are:

- 25 cents per word
(minimum \$3.00)
- "Blind" ads \$2.00
additional
- All letters capitalized
35 cents per word

Each ad insertion must be accompanied by a check for the full cost of the ad.

Deadline for acceptance is 30 days prior to the date of the issue in which the ad is to be published.

This classified section is not open to the regular paid product advertising of manufacturers.

FOR SALE

UNUSUAL SURPLUS AND PARTS Catalog. \$1. ETCO Electronics Dept. E.S., Box 741, Montreal "A" H3C 2V2 12-73-12t

NEW Canadian Magazine "Electronics Workshop", \$5.00 yearly. Sample \$1.00. Ethko, Box 741, Montreal "A" Canada. 10-74-12t

"SUPER SIG" CB Base Antenna. You build yourself in one hour. Simple Plans \$1.00. TIP\$, Box 188, Bruce, Miss. 38915. 10-74-2t

TV GONE OUT?? It may — this is football season you know. Don't risk it. We'll show you how to repair your own. Simple instructions \$1.00. TIP\$, Box 188, Bruce, Miss. 38915. 10-74-2t

ONDA QUADRA is the best electronic magazine in ITALY write: Onda Quadra, Box 404, Mastic Beach, N.Y. 11951 10-74-1t

TEST color CRT's with B/W CRT tester. Instructions \$1. TIP\$, Box 188, Bruce, Miss. 38915. 10-74-2t

BUILD tuner subber from junk TV. Plans \$1. TIP\$, Box 188, Bruce, Miss. 38915. 10-74-2t

TV SHOP 18 yrs. Full price \$16,900 5 yrs. lease plus option, D'AZZO REALTY CO., 4311 SW 41st St., Hollywood, Fla. 33023. 305-625-5424 10-74-1t

SENCORE: SM158 speed augner marker and sweep generator. Like new condition. Included are all cables, IF link detector, and instruction booklets. Paid \$284.95. Sell for \$150.00. Jim Asch, 2122 Chippendale, Houston, Tex. 77018. 10-74-1t

TV & RADIO TUBES 36c EA!! Free color catalog. Cornell, 4221 University, San Diego, California 92105. 10-74-6t

DYNACO-A-R-TRANSISTORS, REPAIR BOARDS & UNITS, SPEAKER SERVICE. SEND FOR PRICES AND DETAILS: BEAR ELECTRONICS-177-E-HILLCREST ROAD, MT. VERNON, N.Y. 10552. 10-74-2t

WANTED

WANTED—ELECTRONIC TECHNICIAN. UNUSUAL OPPORTUNITY FOR ONE WELL QUALIFIED IN COLOR TV. TOP SALES AND SERVICE SHOP HAS 40 YEAR REPUTATION. WE MUST REPLACE RETIRING PARTNERS. MUST BE HONEST, EAGER TO LEARN, AND ENJOY SERVING PEOPLE. CONTACT: WELLS & LATHATTE, VICKSBURG, MS. 39180. 8-74-3t

Engineering

PRODUCT SERVICE Ass't Technical Specialist

Consumer Electronics

The JCPenny Company has an opening in its expanding product service department for an assistant technical specialist. The position is situated in Penny's Corporate Headquarters located in New York City.

Qualified applicants must have an undergraduate degree in electronics and/or electrical engineering with a minimum of 1 to 3 years experience servicing consumer electronic products. The ability to analyze, solve problems, and to communicate—both orally and in writing—on complete technical matters, is essential.

This is an outstanding entry level position for product service management. Send resume and salary requirements to:

JCPenny COMPANY

Executive Search Dept. C-33
1301 Ave of the Americas
New York, N.Y. 10019

An Equal Opportunity Employer M/F

EDUCATION-INSTRUCTION

REPAIR TV TUNERS—High Earnings; Complete Course Details, 12 Repair Tricks, Many Plans, Two Lessons, all for \$2. Refundable. Frank Bocek, Box 3236 Enterprise, Redding, Calif. 96001. 6-74-6t

NOW! Master Solid State Vertical Oscillator-Output Circuit problems. Latest instruction teaches current circuitry. \$1 brings lesson, details. Reidel, Box 9603, Denver, Colorado 80209. 7-74-1t

advertisers' index

B & K Div., Dynascan Corp.	7
Busmann Mfg. Div., McGraw-Edison	31
Castle TV Tuner Service, Inc.	Cover 4
Channel Master	15, 27
Crown International, Inc.	13
Data Technology Corporation ..	17, 18
Eico	50
Enterprise Development Corp.	53
Fluke Manufacturing Company	54
GC Electronics	57
General Electric Company	49
German Electronics Service Corporation	52
Jensen Tools and Alloys	55
Lakeside Industries	59
Lectrotech, Inc.	56
Mallory Distributor Products	3
Mountain West Alarm Supply Co.	52
Precision Tuner Service	Cover 2
Projector-Recorder Belt Co.	55
Quietrole Company	48
RCA Electronic Components	22-23
RCA Parts & Accessories	1
Rohn Manufacturing	9
Sperry Tech, Inc.	52
Sprague Products Company	11
GTE Sylvania- Consumer Renewal	Cover 3
T & T Sales Company	53
TV Tech Aid	51
Tab Books	10
Tech Spray	47
Telematic	48
Tuner Service Corporation	5
Wall-Lenk Mfg. Co.	56
Wayne Electronics	58
Winegard Company	8 54

Give till it helps.

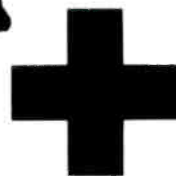

**The American
Red Cross.
The Good
Neighbor.**

A Division of The American Red Cross
Ad

Now you don't have to turn down jobs just because the sets were made in the Far East.

Your Sylvania Distributor has solved one of your biggest problems in semiconductor replacements for imported equipment.

Until now, unless your shop was around the corner from an import warehouse, you probably had a tough problem. Especially for those non-repairable modules.

But not anymore.

Sylvania's new ECG™ 1000 series gives you over 140 new integrated circuits and modules for imported sets right on your distributor's shelves.

And, thanks to our newest interchangeability guide (ECG 212E-4), those 140 parts add up to a lot more

when it comes to the number of types they'll replace.

That means you don't have to watch a profitable repair job walk out the door just because getting the parts could make it unprofitable.

It also means that you've got one-stop shopping for all of your repair jobs, foreign or domestic.

Whether you need semiconductors, picture tubes or receiving tubes, you'll find them all at one electronic supermarket.

Your Sylvania Distributor.

GTE SYLVANIA

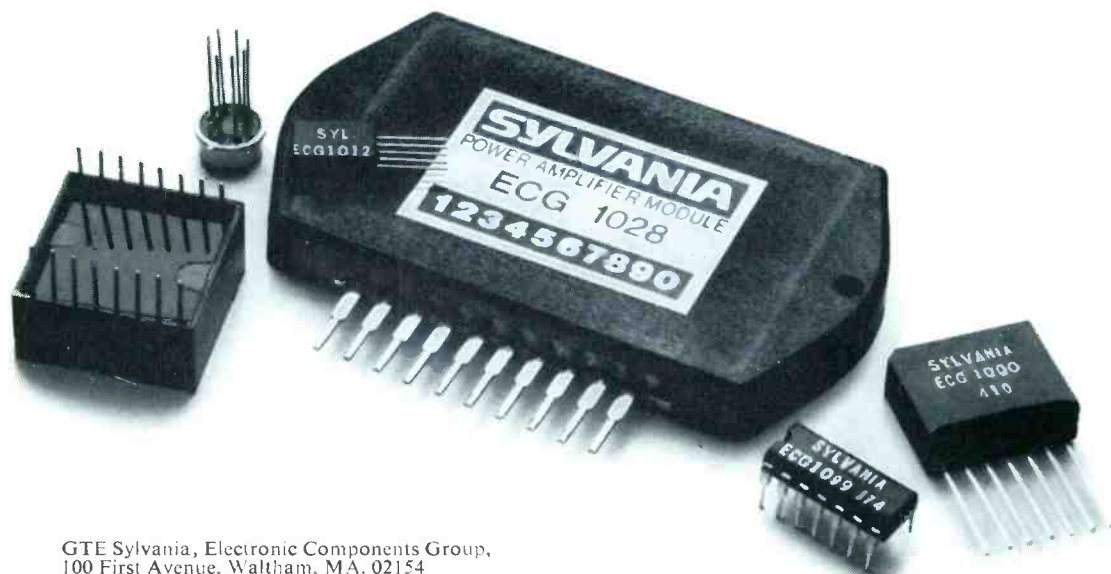

GTE Sylvania, Electronic Components Group,
100 First Avenue, Waltham, MA. 02154

SUBBER™

TV Service Instruments for signal circuit analyzing.



When Castle introduced the TV Tuner SUBBER* analyzing instrument a couple of years ago it became the first practical way to easily test the VHF tuner, UHF tuner and i.f. amplifier system of any TV receiver. Being lightweight, self contained and battery powered the TV Tuner SUBBER* Mk. IV is the first such instrument which may be carried on service calls and used with ANY color or black and white TV receiver . . . at \$45.95 for the battery powered Mk. IV, or \$54.95 for the a.c. plus battery powered Mk. IV-A the instruments have been known to pay for themselves in **TIMESAVING** in the first two weeks of use!



Now we have introduced the Mk. V Master SUBBER*, an instrument which is absolutely unique . . . there is nothing else like it anywhere! It is completely portable and battery powered, practically foolproof in its simplicity of operation when testing ALL the signal stages of any color or black and white TV receiver. The substitution signals available allow tests of the following stages: VHF tuner, UHF tuner, each video i.f. amplifier, video detectors, video amplifiers, 4.5 MHz sound i.f. amplifiers, sound limiter, sound detector and audio amplifier. It includes a signal level meter for testing the antenna signal. Inbuilt telescopic antenna makes the meter adaptable for true field strength measurements. Inbuilt monitor loudspeaker ensures foolproof substitution tests . . . every time!



At \$169.95 the Master SUBBER* instrument is the best bargain in an analyzer that has ever been available. It will save oodles of time in the hands of a professional troubleshooter . . . and help advance the novice to professional status.

All SUBBER* instruments come complete with batteries, connecting cables and comprehensive instruction manual. The Master SUBBER* and Mk. IV-A TV Tuner SUBBER* come complete with wall plug-in transformer for 120vac 60 Hz operation.

As an added bonus, all SUBBER* instruments enable use of the high speed agc system analyzing procedure invented by Castle . . . the first practical method for analyzing agc system defects without confusion.

*A trademark of Castle TV Tuner Service, Inc.

These instruments boast the extra features of all Castle products — advanced technology — modern styling — and they work!

If you need to save some analyzing time . . . you need a SUBBER* instrument!

See your stocking distributor . . . or write for more details and complete specifications.

CASTLE TV TUNER SERVICE, INC.

5701 N. Western Ave., Chicago, Illinois 60645 Phone: (312) 561-6354

In Canada: Len Finkler Ltd., Ontario

For More Details Circle (2) on Reply Card